

SCIENCE OF THE COSMOS

TRANSFORMATION OF MAN

PLEIADES CONNECTION VOL. VIII



**BY
VIOLINIO GERMAIN
&
GYEORGOS CERES HATONN/ATON
"dharma"**

A PHOENIX JOURNAL

COPYRIGHT POSITION STATEMENT AND DISCLAIMER

The Phoenix Journals are intended as a "real time" commentary on current events, how current events relate to past events and the relationships of both to the physical and spiritual destinies of mankind.

All of history, as we now know it, has been revised, rewritten, twisted and tweaked by selfishly motivated men to achieve and maintain control over other men. When one can understand that everything is comprised of "energy" and that even physical matter is "coalesced" energy, and that all energy emanates from God's thought, one can accept the idea that the successful focusing of millions of minds on one expected happening will cause it to happen.

If the many prophecies made over thousands of years are accepted, these are the "end times" (specifically the year 2000, the second millennium, etc.). That would put us in the "sorting" period and only a few short years from the finish line. God has said that in the end-times would come the WORD--to the four corners of the world--so that each could decide his/her own course toward, or away from, divinity--based upon TRUTH.

So, God sends His Hosts--Messengers--to present that TRUTH. This is the way in which He chooses to present it, through the Phoenix Journals. Thus, these journals are Truth, which cannot be copyrighted; they are compilations of information already available on Earth, researched and compiled by others (some, no doubt, for this purpose) which should not be copyrighted. Therefore, these journals are not copyrighted (except *SIPAPU ODYSSEY* which is "fiction").

The first sixty or so journals were published by America West Publishing which elected to indicate that a copyright had been applied for on the theory that the ISBN number (so necessary for booksellers) was dependent upon the copyright. Commander Hatonn, the primary author and compiler, insisted that no copyrights be applied for and, to our knowledge, none were.

If the Truth is to reach the four corners of the world, it must be freely passed on. It is hoped that each reader will feel free to do that, keeping it in context, of course.

SCIENCE OF THE COSMOS
TRANSFORMATION OF MAN

PLEIADES CONNECTION VOL. VIII

ISBN 0-922356-52-1

First Edition Printed by America West Publishers, 1991

Published by

AMERICA WEST PUBLISHERS
P.O. Box 986
Tehachapi, CA. 93581

Printed in the United States of America
10 9 8 7 6 5 4 3 2 1

TABLE OF CONTENTS

<u>CHAPTER</u>	<u>PAGE</u>
INTRODUCTION	7
THURSDAY, SEPTEMBER 5, 1991.....	7
CHAPTER 1	13
WEDNESDAY, AUGUST 28, 1991.....	13
DISCUSSION.....	13
MODERN SCIENCE IS TRAGIC.....	15
FOUNDATION OF PRESENT BELIEF.....	16
CHAPTER 2	25
EXPANDING UNIVERSE.....	25
THE COULOMB LAW.....	25
SOLENOID COILS IMPROPERLY WOUND.....	27
RUTHERFORD-BOHR THEORY OF ATOMIC STRUCTURE.....	32
NEW LAWS OF THERMODYNAMICS.....	34
NEW LAWS.....	36
THE LAWS.....	38
CHAPTER 3	40
THURSDAY AUGUST 29, 1991.....	40
SOUND AND SILENCE.....	40
PHOTOSYNTHESIS AND THE GEOMETRY OF SPACE.....	42
THE GEOMETRY OF SPACE.....	46
CHAPTER 4	52
NATURE OF LIGHT.....	52
SUMMARY.....	63
CHAPTER 5	66
FRIDAY, AUGUST 30, 1991.....	66
COMMUNISM FALL?.....	66
NOW IS THE TIME!.....	69
LAWYERS; YOU HAVE LAWYERS!.....	70
MISSING 13TH AMENDMENT "TITLES OF NOBILITY" AND "HONOR".....	71
MEANING.....	72
HISTORICAL CONTEXT.....	72
DON'T BANK ON IT.....	73
PAPER MONEY.....	75
CONSPIRACIES.....	75
TITLES OF NOBILITY.....	76
INTERNATIONAL BAR ASSOCIATION.....	77
HONOR.....	78
WHAT IF?.....	79

CHAPTER 6	81
PARADISE FOUND?	81
THE AMENDMENT DISAPPEARS.....	84
SIGNIFICANCE OF REMOVAL	85
THOSE WHO CANNOT RECALL HISTORY - - -	86
CHAPTER 7	90
SATURDAY, AUGUST 31, 1991.....	90
THE PURPOSE OF THE CUBE IN NATURE	90
CHAPTER 8	100
NATURE OF LIGHT	100
CHAPTER 9	111
COMPLETION: CONSTRUCTION OF WAVE PRINCIPLE	111
SEARCH FOR MORE SECRETS	113
CHAPTER 10	125
SUNDAY, SEPTEMBER 1, 1991	125
INTO SPACE THROUGH OPEN DOORS: THE ROAD MAP	126
POWER PROJECTION.....	134
TRANSMUTATION	135
SOLAR ENERGY	140
TOO SIMPLISTIC?.....	143
CHAPTER 11	145
THE TRANSFORMATION OF MAN	145
SPIRITUALITY OF LOVE.....	145
THE LIVING OF LIFE	147
HOW TO KNOW GOD.....	148
MANIFESTATION OF LOVE IN CHARACTER.....	150
KINDNESS	152
HUMILITY	153
HONESTY	153
CHAPTER 12	155
MONDAY, SEPTEMBER 2, 1991	155
LABOR DAY	155
GOD'S PURPOSEFUL INTENT FOR MAN and	
THE POWER OF MOTHER LOVE	156
UNIVERSAL CREATION.....	163
CHAPTER 13	166
WEDNESDAY, SEPTEMBER 4, 1991	166
GUN CONTROL?	166
LEGAL SHENANIGANS	169
REVELATION	170
CHAPTER 14	173
WEDNESDAY, SEPTEMBER 4, 1991	173
WORLD DESTINY LIES IN MOTHER LOVE	174
AGAIN--HUNG UP ON REINCARNATION.....	175

GRATITUDE

Special gratitude is given to artist Barry Hughes for his hours and hours of labor in making the supplemental illustrations.

INTRODUCTION

REC #1 ATON

THUR., SEPTEMBER 5, 1991 10:15 A.M. YEAR 5, DAY 020

THURSDAY, SEPTEMBER 5, 1991

"I would not send lesser unto my children"--I am Aton. If you know not who IS Aton, I hope that you will do enough homework to find the answer.

As with typical mankind, you ones wish to begin at the end of the story and have others assume responsibility for YOUR education. No, that will not serve in this instance--we have purposely brought you over 40 books of insight, Truth and instructions beginning with your plight, your direction, your solutions and your divine reclamation through, and by, God. We have brought you full and detailed explanations of the working details of the Cosmos, Universe and what God is and how the cycles of perceived life and death "work". We have put it in a format which you, as man in trouble, can easily understand--the rest is up to you.

Does this mean that the JOURNALS are through? No indeed, we shall continue until the play is finished; however, it means that the eight most important books of your planet are now before you--as you use this one. I am sorry to disappoint ones who either feel "another" can explain it TO YOU and/or YOU who feel so wise as to explain and foist off your opinion of the material upon another in explanation. It is a time of self-opinion and discernment and understanding, for the transition will not be made except by those who have come within the KNOWING! This does not mean that you have to understand every working detail--but you MUST comprehend within that which is the overall.

As we draw this JOURNAL to a close, already the next is under way. Therefore, I take this opportunity to thank this scribe for the relentless pressure of the multitudes of hours in service, interspersed with overwhelming personal problems, assaults and myriads of questions from readers which have had to be answered. To Dharma I dedicate these writings for it is a legacy being presented to mankind and left for all the expected future wayfarers through this physical experience. She leaves no human label attached--only the love and hope that mankind's destiny in divine purpose be found and fulfilled within God's homecoming.

The PHOENIX JOURNALS AND *EXPRESSES* are directed and given forth from the higher brotherhood sent forth as the Hosts for the preparation of this time of cycles when this civilization will make transition into higher understanding or return to the ages of darkness. This is by no means the ONLY source of information--all information presented here is but integration of the WHOLE that you might isolate the necessary knowledge from the lies.

The final promise for this civilization prior to the final fulfillment of the "prophecies" was that Man would be given the WORD and it would flow to the corners of the globe so that each could make choices of his divine journey and so it IS. More will flow until the ceasing of this manifested experience and myriads of subjects, from underground research, growing of foodstuffs, to efficient dwellings, will be shared with you--but Germain has now given you the METHOD for transmuting all things to attain the level of higher understanding to match that of your elder brothers come to bring you safely into your next experience.

When my speakers and "professors" say that: "Here is the information and you will do with it as you please," and "Here is the information, I care not what you do with it," I have shocking news for you who live in your central "Me-tight" cells. They care not one iota more for YOU than for another nor one iota less. They would "prefer" that YOU join with them, understand, accept and come to the place of KNOWING which brings you all, as a group, into the places of safety and comradery. They do not, however, "care" (in your use of the slang interpretation of "I don't care"), what you choose to do with the information. That is solely up to you and your freedom of choice. You must rise above your "ME" as regarding all that comes down, for you now represent only a tiny 6&1/2 billionth of their concern. Their higher KNOWINGNESS is offered unto you and in that KNOWING it is also recognized, in total, that you may do that which you will and eventually you WILL come into KNOWING and the final leg of your journey WILL BE BACK unto the Creator and it will be by THIS ROUTE, THROUGH THE RECOGNITION OF YOUR SELF WITHIN THE COSMIC BEINGNESS AND KNOWINGNESS. Therefore, it is in love and total GIVING and Regiving, as you share your love with them, that they say, "What you do is for you to choose and I 'care' not what you choose for it is YOURS to choose and I JUDGE not your choice." Then, if you turn from them they must allow you to do so for it is not "theirs" to interfere. As to the Highest Cause--you may turn away, also, and you will be allowed to do so--but unlike the "brotherhood" who come "AS YOU" and will leave you to your choices, God will continue to be present should you change your mind. But, if the "lift-off" of physical form has passed, it will be only in the soul ascendancy for this manifested journey will automatically be ended.

At this time of transition and change of the planet--many will not be through with this physical experiencing segment and will retain this present expression to guide, rebuild and structure. All and EACH has a unique and specific purpose which fashions the WHOLE--but, dear ones, the journey into life will continue and continue and continue, either with presence of higher knowledge which gives you progression or placement suitable to "continue" from the level of understanding in which you make that transition in this civilization of growth. You as a civilization cannot and will not die, for the seed shall never perish--you are as eternal and immortal as God Self. It is strictly a matter of learning your lessons and graduating or failing. You will move on, you will go back and "pick up" your lessons or you will remain retained at the same level until you DO LEARN. There will be no "religious" rapture for a select self-appointed "few". Evil will not be allowed in the higher frequency dimensions which

function within and through the Laws of God and within total balance with the Cosmos and Nature.

You are being shown the problem, the way to change as to needs and how to do it. **GOD WILL WORK WITH YOU; NOT INSTEAD OF (FOR) YOU!**

Some of you continue to seek and entangle yourselves with other persons who say they bring Truth and are the way. So be it. I now command that my Hosts cease responding in perception unto ones who ask about this one or that one and do so through earth methods of physicalness, i.e., write Hatonn through Dharma and await a response on a piece of paper from Dharma. You are given all you need to discern for self--if you use that which has been given. If you have not the "time" to read all--it is your choice! Always, regardless of the choice you make--it IS your choice. For instance, ones by all sorts of names and directions are inquired about in great numbers. I tell you--HERE IS ALL YOU NEED. If you want other--take other but I ask that no discernment be made for you ones until AFTER you have studied carefully the material given and all clues and guidelines for discernment are integrated and then the journey "within" in devout inquiry for guidance is made.

I can tell you that there are ones who contribute--and THEY recognize the Truth and know this resource. If they do not--they are not of Me. You must make that discernment. I care not if one tells you whole truth and then says he knows not Aton--in one breath he has said he is false.

If one "teaches" to the "senses" of man without full intent of moving totally FROM the senses and into Truth of spiritual soul--he is false and you will be trapped in the physical experience because YOU are not your body or your brain--YOU are the MIND-SOUL which is totally non-physical in all projection from onset of seed to return unto the seed. Physicalness is merely a projected manifestation of experience to allow for soul growth. Some of you learn very, very slowly and experience quite heinous perceptions--but it is the way it is. No more and no less.

It is the time of opportunity of a civilization to move as a whole into higher understanding and wondrous experience although not in final perfection for you are still primitive in knowledge. It is also a time of higher beings to integrate and participate for both their own growth AND yours. And, it is a time of very high recognition of many who have returned to walk this blessed planet through a time of birthing. YOU will fit wherever you will fit! That is the portion which is up to you in the choosing. Those who will remain in evil and ignorance are the ones who will decline and denounce the WORD in all instances--they will be left, no more and no less. They have no ability nor wish to find God--ONLY ESCAPE OF RESPONSIBILITY. They will be left to their choices and I believe you will note that it probably will get very "hot" and "miserable" on your place as the Elite evil personages enslave the rest of you. Will you "wish" you had changed? Some--most will simply not even recognize that they had a choice. Is this fair? No, it IS JUST! All ones will have the same OPPORTUNITY TO AVAIL THEMSELVES OF TRUTH--

he who chooses to deny, is getting that which is actually "fair" for he asks to be left alone in his experience. God is not force nor coercion--God is total LOVE, supplier of the WORD, shower of the way--and ALLOWER TO AND OF EXPERIENCE.

Following this, the thrust will be in bringing more enlightenment and assisting with the turn about in scientific knowledge as it is safe for it to be brought unto you. Prior to that massive revelation you must do certain things which will allow continuance of your planet with ability to function--that means that specifically you in America MUST save your nation from Dictatorship and Bank ownership--that means you MUST save your Constitution and bring your nation and the vipers who have stolen it, into and under control. Then you must begin to break the chains of the brainwashing and deliberate destruction of the species by the adversary who has locked you in the pits of hell while playing to your physical "senses" and deadening your spiritual evolvment. Now know, chelas, that he who "dies" in this level of ignorance and delusion is DESTINED TO REPEAT IT IN THE SAME CIRCUMSTANCES FOR EACH MUST LEARN THE TRUTH OF GOD AND PURPOSE AND EXPERIENCE OF IMMORTALITY.

False prophets and how do we prove who we are? We do not come to "PROVE" anything unto you. It is time you ask others of the physical plane to PROVE THEMSELVES UNTO YOU! THEN, IT IS TIME YOU PROVE SOMETHING UNTO ME! WHO MIGHT YOU BE? WHAT HAVE YOU DONE WORTHY OF CONSIDERATION OF HIGHER PLACEMENT? WHY SHOULD I DO ANYTHING AT ALL FOR YOU? WHAT HAVE YOU--GIVEN--THAT MIGHT BE REGIVEN IN GREATNESS? WHAT HAVE YOU DONE FOR ANY, SAVE SELF? WHAT HAVE YOU GIVEN OTHERS THAT YOU MIGHT BE REGIVEN IN ABUNDANCE? YOU CANNOT HAVE ONE WITHOUT THE OTHER! WHAT HAVE YOU DONE TO BE WORTHY OF "PROOF"? WHAT HAVE YOU DONE IN GREAT INTENT TO BE WORTHY OF RESPONSE? DO YOU RECOGNIZE RESPONSE WHEN YOU RECEIVE IT? DO YOU TURN AWAY FROM THAT WHICH YOU KNOW YOU SHOULD DO IN ORDER TO FIND EXCUSE FOR NOT "GIVING"? SO BE IT FOR THESE ARE THE QUESTIONS THAT SHALL BE USED AT YOUR TRIAL REGARDING YOUR ACTIONS IN THIS PHYSICAL MANIFESTATION.

DID YOU DO ALL YOU COULD IN ACTIONS TO ASSIST YOUR BROTHER FIND HIS WAY? DID YOU REALLY? OR DID YOU DECLINE SELF TO GIVE UNTO ANOTHER? BE VERY CAREFUL HOW YOU ADD INSULT ONTO THE WOUNDED OPEN INJURY. WHEN YOU HAVE GIVEN ALL, THEN, AND ONLY THEN, HAVE YE GIVEN SUFFICIENTLY. THE MOMENT YOU REACH THAT POINT OF THE PENDULUM SWING--THEN AND ONLY THEN, CAN THE MULTIPLIED ABUNDANCE BE REGIVEN UNTO YOU.

I have never left of thee--you have turned from Me to play in your fleshly pleasures and seeking of material gain.

Day unto day I have gone the way before you; night after night have I made the path more clear and strengthened your hearts and offered you wise counsel. I have sent teachers and you have also turned them away and denied them and therefore denied ME. WHAT HAVE YE DONE TO EARN MY GIFTS? O MAN--WHAT HAVE YE DONE TO EARN MY GIFTS?

Beloved ones, be warned! The enemy pursueth and plies you with substance and as ye partake, he enters within and takes control of all that is of your physicalness and then shrouds your mind that you are blinded and confused. Evil stalks you as the lion does the sheep--waiting until you are unguarded and reach out for that bait within the sensual trap.

But you can see Me in a twinkling! Ye need not wallow in the mire of the evil entrapment for the heavens shall be opened and you shall discern Me as I am. You shall see the great sights for mankind is omnipotent unto himself--though he knows it not. He is an angel unto himself, unto himself ministering. HOW DO YOU MINISTER TO SELF? The day is coming soon when those who watch faithfully shall see a bright cloud, beginning no bigger than a hand; mark well the parable!...the day will dawn when man shall see a witness unto his waitings in the triumph of his sensings.

There will come the ONE who was not a myth, though all else denied HIM; there is ONE who makes you receivers of miraculous appearing--who gives you your visionings and your Truth.

That which is of ME is that ONE for whom you wait for He is sent again as graduated messenger and it is within the time of sorting.

Wherein does your seemingly separate identity differ from My own, I, Aton?

Allow your KNOWING to answer you for you have now the information upon which to base your knowledge. You have a Mind which is God's Mind. You have a body which is of exactly the same material as God's body. Your body can have the same perfection as God's body when you put the same perfection of God's balanced thinking into it. Your body has a heartbeat which synchronizes with the heartbeat of God's body. You breathe in and out exactly as His body breathes in and out. Your body differs only from the universal body by what you put into it that you should not put into it. It has been created out of Light by dividing it into light-waves just as God's body has been created. It lives and dies just as every other unit of God's body lives and dies. God created His body by His balanced thinking. If you create your body and your identity with My (God's) balanced thinking, you can say: What God is, I AM. "MY FATHER AND I ARE ONE." YOU ARE NOT ALONE--FOR YOU ARE THE UNIVERSE IN WHICH I AM.

I AM THE CAUSE--YOU ARE THE EFFECT. WHAT HAVE YOU EFFECTED TO BE WORTHY? SO BE IT!

I EXPERIENCE WITHIN YOUR KINGDOM OF ACTION AND EFFECT AS YOU TAKE "ACTION" IN YOUR PERCEPTIONS--BUT--YOU CAN ONLY ENTER INTO ***MY HIGHER PLACES THROUGH THE LAWS, BALANCE AND HARMONY GIVEN FOR YOUR GUIDELINES. WE BOTH HAVE ALL THE TIME IN THE UNIVERSE TO COME INTO THIS WISDOM OF TRUTH.***

I AM THAT YE MIGHT BE--I AM GOD, WHO MIGHT YE BE?

ATON

CHAPTER 1

REC #2 GERMAIN

WED., AUGUST 28, 1991 9:57 A.M. YEAR 5, DAY 012

WEDNESDAY, AUGUST 28, 1991

DISCUSSION

This is a crucial turning point in our efforts to lead you to a full comprehension of your own personal identity as an extension of the God-Identity. These upcoming units of discussions will be referring to the science of the recognition of the Truth of the Cosmos.

We have been dealing with the Science of Man. We shall now think in terms, please, of Knowing the Cosmos. The purpose is to give you a comprehensive understanding of your Oneness with the God-Identity by enabling you to transcend your physical-man identity completely and thus become the "Knower of the Cosmos" instead of merely a thinking extension of the Creator whose limitations of thinking are bounded by the ever-conscious fact that the man-idea is but a part of the whole and not the whole. You MUST NOT CONSIDER THIS AS BEING JUST ANOTHER EXERCISE IN MEDITATION FOR IT IS NOT AND IF YOU CONSIDER IT TO BE SO--YOU WILL MISS THE LESSONS INVOLVED. You ask and ask "how to" and yet, you must first learn "what is" or it values you not to know "how to" for you will negate your own intent. The LAST thing we desire is to have a bunch of zombies in a state of trance, sitting for hours or weeks or months. Communion must become your instant state of being--not something you struggle for and which evades you. Clear your space, discard all entrance to dark energies and get in balance in intent to recognize God--He is already present so what is the big deal? All you need is to learn to "LISTEN".

When you arrive at this stage of where you can focus your Consciousness to higher "hearing" and sever your consciousness from the seat of SENSATION IN YOUR BODY, you will then be that KNOWER and THINKER of the WHOLE instead of being bound to only a part of it by the limitations of your body. As long as you are thinking about sitting a certain way, drinking a certain tea, eating a certain "meditation" food or holding an amulet a certain direction--you are focusing on the wrong thing. Any of those CAN be tools but they usually become THE OBJECT OF FOCUS--NOT GOD. God is with you constantly--ALWAYS. You must not believe you must GO somewhere OR DO some ritual--you have to simply go within into the quiet where God is located--not out there somewhere where nothing IS. As long as you look for God (out there) you will never find HIM. You most certainly CANNOT EXPECT TO FIND GOD THROUGH ANOTHER. The "OTHER" can only recognize that which is his. As you then become "a cosmic being" who recognizes and acts in

unity with The One Cosmic Being, you will BE that One and will knowingly be able to say, "I and My Father are ONE."

That stage is the goal of ALL mankind, for every living thing on earth is perpetually seeking God whether it knows it or not. Every living thing is perpetually turning toward the visible light which God invisibly centers no matter whether that thing is man, flower, tree, wave-current or atom. All are living things and all are light, for naught IS but light. Light is the ONE THING, the ONE INTELLIGENCE, the ONE POWER in the universe. Those searchers for God who have conceived the ONE BEING as having wrath and anger have cruelly retarded the human race in its search for the God of Light and Love which Messengers of all time have described, but this barbaric race of humans has never been able to comprehend their meaning.

The greatest contribution any human can make for human race transcendancy is to give a dynamic description of God which will withstand the tests demanded by laboratory methods and standards. The final JOURNALS of this series will fulfill that requirement and give to the world a concept of God which is so undebatably true that an atheistic person or nation would be wholly impossible in a normal society.

This new series of lessons will give a complete roadmap from static space to dynamic motion and back again to static space. Such a teaching must be scientifically based, for one must first know God's methods and processes before one can intellectually comprehend God. Even then, one will not know the spiritual God until he has been enabled to BECOME God by completely severing his physical self from his Cosmic Self, for an intellectual comprehension is still bounded by body-awareness while Cosmic comprehension is not.

To unfold this concept of the universe in so brief a description as can be given through these lessons will necessarily leave much to be added in detail by scientists, philosophers and mathematicians if they will but come into acceptance of the fundamental principles, but if what is given herein with its diagrams is received with open minds, it will advance the knowledge of the human race and its consequent higher status and completely change the perception of Man in less than one generation. When it is accepted you will find yourselves already living in that advanced civilization. Let us consider this JOURNAL TO BE COSMIC SCIENCE.

I suggest you put aside all preconceived notions regarding this subject except as presented by ones such as Walter Russell, Nikola Tesla and ourselves prior to this particular writing. If you entangle it with hearsay from ones such as Sagan, Friedman and the New Age channels--you err greatly for I do not sanction "New Age" concepts and do, in fact, feel that that very intent, alone, can destroy your civilization. You are in a Cosmic Age of growth and transition--not a New Age of Magic and unbased suppositions. What we give you is also ability to PROVE the concept for when the students are ready the teacher is always made available and as we move from this into the next class--you who prepare, will be ready to also move. The heavens and the bodies therein have great, great meaning but not as the Astrologers use the charts for

fortunetelling. They can either be a deceiving bunch of nonsense or utilized as the tools intended--bringing unfolded wisdom beyond the imaginings.

MODERN SCIENCE IS TRAGIC

The ultimately supreme need of the human race at this stage of unfolding is the discovery of the existence and identity of a comprehensible God by methods and processes which will meet the requirements and standards demanded in the laboratories of science as well as within the heart and consciousness of man.

The tragedy of modern science is that it has already made this supreme discovery but is not aware of it. Because of the present-day misconception of the universe, which the Creator built in the image of Cosmic imagining, and of God Himself, Whom religion has pictured as some kind of angry god of wrath who wreaks vengeance upon so-called sinners--instead of conceiving Him as a God of Light and Love--fear has been created by man which leads to war and the preying of man upon man, and is the dominant note upon which our civilization has been constructed. As long as fear dominates the human race instead of love, it will create the disunity which is characteristic of its many religions. When the day comes that fear leaves man and love enters, the age of slaughter of man by man will end and the age of character will begin.

In human justice, we are not blaming religion alone, for science and religion are father and mother mates--science being the father. All down the ages, man's discoveries in science have progressed your civilization to the point where a man's world is its resultant effect. Man has always been master of the world and man's nature to conquer has always suppressed the love nature of woman.

Deeper still than science, which should have discovered the God of Love (BALANCE), or religion, which created a god of fear and wrath, is the basic cause of man's self-made troubles--and that is MAN, himself, who strayed from God's Natural Law at the dawn of Consciousness and has continued to do so to this very moment.

Alexis Carrel was right in saying that all of man's institutions--and these include government, industry, education and home relations--were man-governed and out of balance with themselves and with each other and must, therefore, all be changed to obey the laws of Nature.

This is why we keep making the same statement over and over for your attention: *"God will work WITH you but not FOR you."* It is also why you must understand the law of rhythmic balanced interchange between all opposite pairs in Nature.

We will continue herein, to give universal science a clearly delineated road map into space to clarify the mysteries which it has for so long been unable to fathom.

When the day comes that it does so, a cohesive, unified and forever enduring civilization will emerge, resulting in the transcendency of man from his present lowly

status to that final goal of his Creator's intent where he can knowingly say, "I and my Father are ONE."

FOUNDATION OF PRESENT BELIEF

This refers to "International Science". It is strange but true that so little a thing as a wrong terminology adopted by science can be blamed for the tragedy of man even as so little a thing as a flaw in a rail can throw a whole trainload off its course and destroy many human lives. **That wrong terminology is based upon the concept of an electromagnetic universe.** In early writings we have had to refer to it in the same terms to bring you to this point wherein we can now begin to give you insight. Up to this writing we have had no connection with you wherein you could understand a different set of terminology or hear our explanation and definition of that which already exists. The rest of this "course" will be, therefore, devoted to the way international science has reached its high pinnacle of success in commanding matter to do its bidding and obey its will without knowing the WHY, and yet being very skilled in knowing the HOW. One without the other is the most destructive element introduced into a civilization for it causes chaos and havoc with no means of correcting same nor rebalancing that which is unleashed with only ignorance of controlling the consequences.

In order to comprehend the power of motion in its desire to create heat and visible light out of the cold invisible Light at rest, which Mind is, Creation must henceforth be looked upon as a universe of Mind-imagining having no reality and be known as AN OPTICAL UNIVERSE OF GRAVITY-CONTROLLED LIGHT, **for God is Light and God's Mind THINKS in waves of light.**

The Christ, the consummate Illuminate of all time, told you that two thousand years ago but you didn't comprehend its meaning. The Krishna of the Bhagavad-Gita also told you that three thousand years ago but only the people of the Eastern culture faintly comprehended it. The "Ancients" always knew it and handed it down since the "beginning" through the oral tradition of holding knowledge--and now their offspring have all but "forgotten" also. I shall now tell you WHY man has not yet comprehended those teachings, for which he is paying the dreadful price by sinking into long ages of periodic mental darkness. We will begin at the beginning and clarify each step briefly and expand on them later.

The secret of Creation lies within the light-waves of motion which gravity compresses into rings of light in which density first increases toward the outside by thrusting outward from within until the centering holes have been closed into hot spheres. Density then increases in the inward direction. This is accomplished by the octave-wave process which multiplies power by projecting it from the stillness of its Mind-source by dividing it into mated pairs which science calls the elements of matter. This constitutes the sex-principle of life which science *has so strangely neglected to observe as being the BASIC FACTOR OF MOTION.* This clarifies the meaning of the divided curved universe of motion from the undivided

universe of rest which the Illuminates, sages and prophets of the ages have tried to define. (See Figure 29)

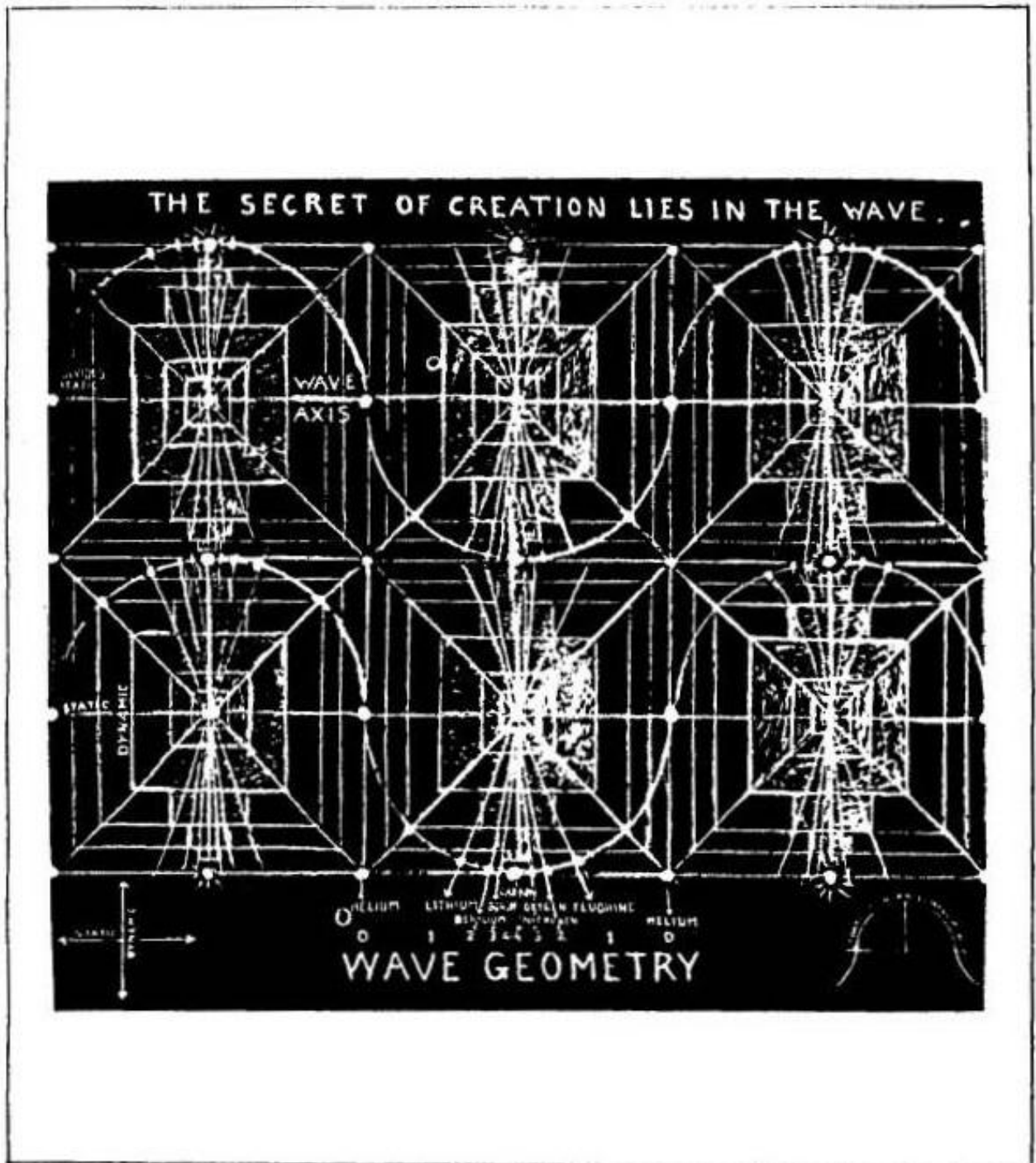
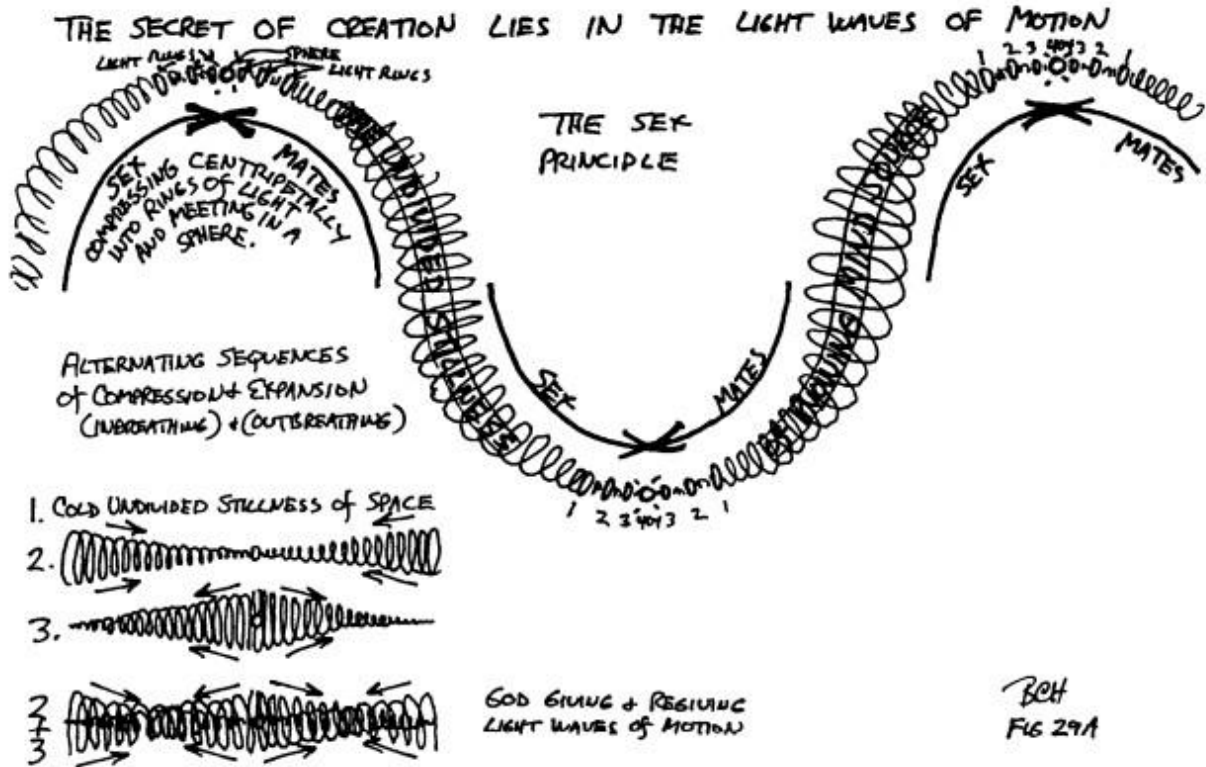

FIG. 29

Waves compress the invisible light of cold space into visible light of incandescent suns. They then expand it to return visible light back again into cold space. This they do by means of gravity-controlled curvature which is God's only tool to work with in creating this universe of motion.

Man's science has already unknowingly conquered this principle, as you shall see. You shall also see that knowledge of the wave is man's measure of his power to command matter.



Failure to recognize the secret of life as being the sex principle which lies within the motion of light-waves: The alternating sequences of compression and expansion are the very cause of motion, as indicated by their sequential equally interchanging inbreathings and outbreathings. It is these very generative, **compressive in-breathings** from the cold of space which cause the multiplication of heat in your body or in the body of the sun. **Radiative out-breathings** then divide it by expansion. To designate this effect of compression-expansion sequences by electric terminology such as positive and negative charges is totally unlike Nature's processes of creation of matter. It overlooks the fact that these action-reaction sequences are interchangings between the heat and cold of the divided spectrum of matter. Man's laboratories are unaware of the fact that they are unknowingly on the way to discovering the transmutation process, for that process demands the power and knowledge to control gravity in such a manner that they can compress or expand it to high limits. We will give the basic principles which underlie the transmutation principle later. Don't despair--we have at least two more volumes of PLEIADES CONNECTIONS--at least--and perhaps twenty if it is required. Sorry about that, Dharma.

Why, therefore, relate effect to electricity when light and power companies have only light and heat to sell? Why, also, relate them to magnetism when they have no magnetism to sell? Power companies can produce light and heat only by resistance to

motion, which induction accomplishes. ***Friction, induction and compression ARE ONE.***

If a man scrapes his feet on a rug and touches metal, he will produce a light only. **Why call it electricity?** If a meteorite, or a spacecraft, springs into visible light by the friction of resistance through the atmosphere, it produces light only. **Why call it electricity or electromagnetism?** One can produce visible light and great heat by focusing centripetal rays upon cold bodies through biconvex lenses, **but that would not justify the light thus produced to be termed opticity.**

The term "magnetism" is also unjustifiable. The word GRAVITY would be used instead, for gravity both multiplies and divides by thrusting inward from without to compress and outward from within to expand. In this manner, gravity controls light by controlling its curvature, and Mind also controls gravity by limiting both outward thrusts to the cube mirror planes of zero curvature which we will make much of later on. (See Figs. 30, 31, 32 and 33) This is in complete opposition to the Newtonian law of gravity which claims that gravity pulls inward toward a center and that matter attracts matter. It is also in opposition to the second law of thermodynamics which claims that energy cannot run uphill but only downhill.

In later pages, we will give seven new laws of thermodynamics which are in accord with Nature's wordings. We will clearly explain the nature of light, which is to give outwardly from itself in accordance with the love principle upon which the universe is founded. We will also explain why the more light of love that Nature gives out from itself in the one and only direction of motion, the more intense is that light and heat. The opposite reaction to giving is not **receiving**; it is **regiving**, as life gives to death and death regives to life.

Factually, there is no inward pull of light toward a center nor are there such effects as attraction or repulsion of matter (meaning light) to other matter. We know that this statement will cause a storm of protest from scientist and layman alike, but if both will withhold judgment until we analyze the laws of Coulomb and Newton, we will dispel that mystery.

No scientist can create energy by pulling in inward from within.

It must be produced by thrusting inward from without, as an automobile tire is pumped. That means by compression. If the tire were made of a metal which could not be burst by that compressive inward thrust, it would cause it to create a ring of intensely hot visible light at its center and density would then increase inwardly, as stars and planets increase their densities in the inward direction. Science has already done this but does not admit that the energy thus created was **projected** into it, for science claims that matter itself is energy.

Science creates air-conditioning and refrigeration that way. By continuing the freezing process to near absolute zero of cold, it can also multiply the power of conductivity of such soft metals as aluminum to equal that of harder metals such as copper.

Many laboratories have already done this, and the Du Pont Company has created what it terms new non-conductive substances by the opposite direction of expansion. All of these laboratories have been on the way to a solution of the principle of transmutation but, unfortunately, are unaware of it. Furthermore, they have also been on the way to the control of gravity, which a certain distinguished scientist said would climax all discoveries by giving man an unlimited command over matter. **Science has long ago been in control of gravity but is, unfortunately, also unaware of that.**



FIG. 30

The only way Nature or man can produce visible light is to compress a large area of invisible rays into a small area by focusing it to a point. This produces a cone-shaped form such as a cyclone. Its ever-increasing speed of motion generates multiplied energy which then divides to radiate that light back into cold space.

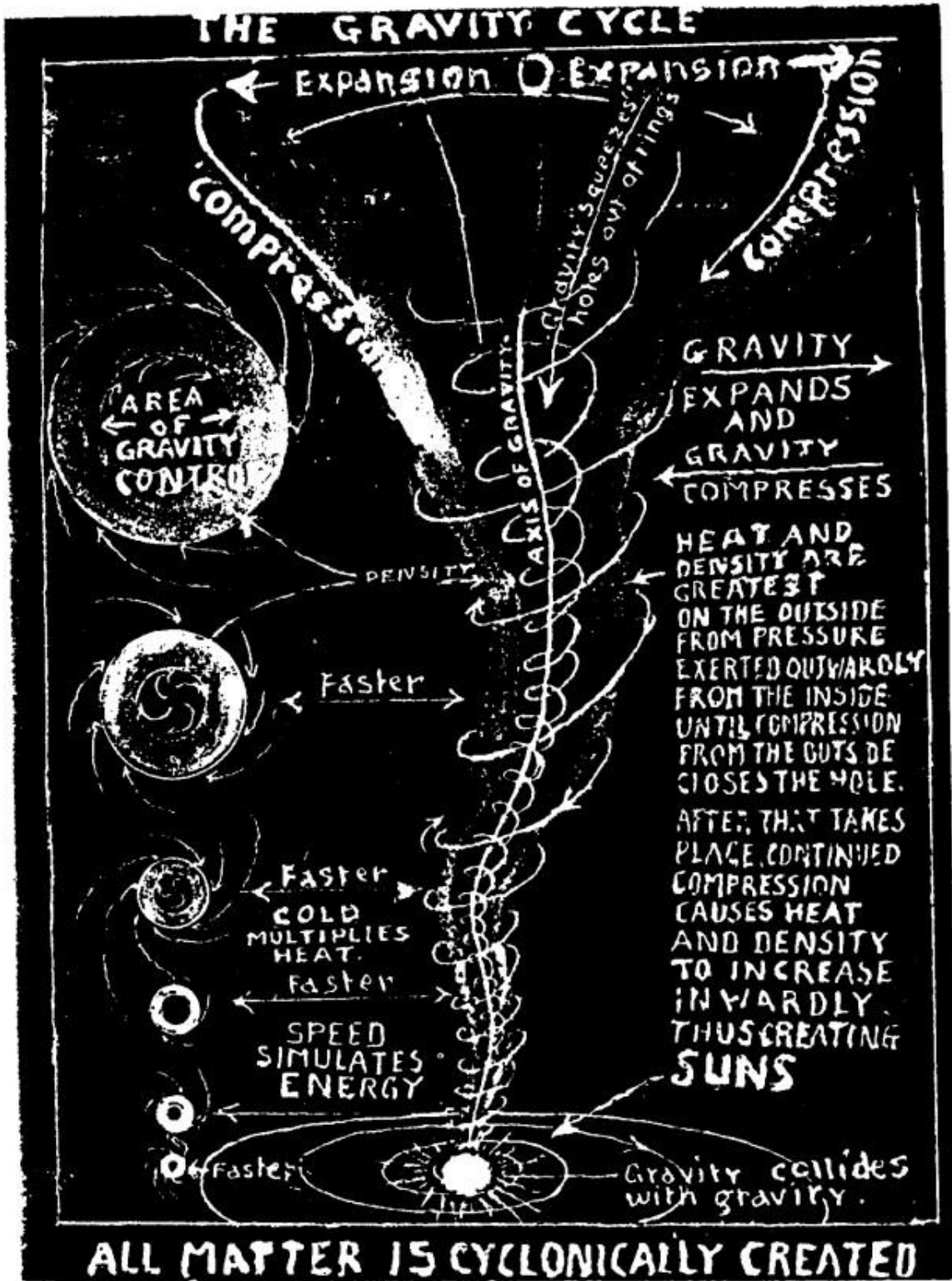

FIG. 31

The above vertical section of the cyclone pictured on the opposite page illustrates both compression and expansion processes of Nature which are in every effect of motion, inbreathing and outbreathing, life and death, growth and decay, and many others.

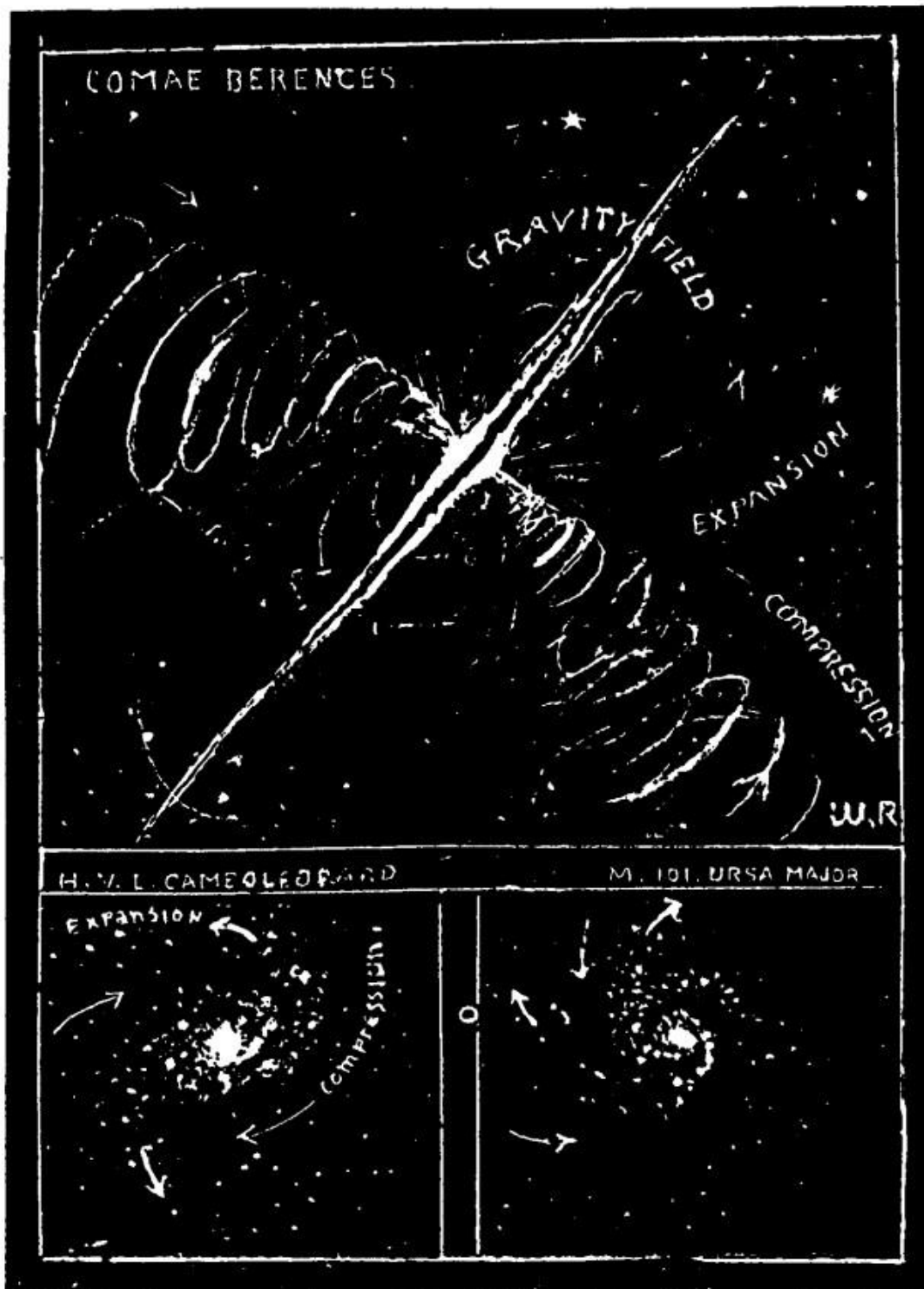

FIG. 32

The above represents two cyclones in collision, like the one in collision with the earth as pictured in Figs. 30 and 31. This requires thrusting outwardly from cold space toward the inward direction to generate heat, and then thrusting outwardly from within to radiate heat back to cold space. Witness the tremendous thrust of heat from the solar corona.



FIG. 33

All matter is composed of light rings in which their density increases from the inside holes toward the outside rings. The blue of the spectrum centers these holes and the red of it occupies the outside. For a good example, see a color photograph of the Lyra ring. When compression closes these rings, they become spheres in which density increases toward the center and the white hot yellows and reds of the spectrum center them. As spheres cool, they oblate and cast off rings. Holes then develop on the inside as the rings radiate their heat into cold. Thus the light-wave cycle is created. The above planet is two stages of Saturn which the sun has cast off to cool.

The diagrams herein given explain more fully than words can how the outward thrust direction controls both the apparently opposite directions of compression and expansion, centripetal and centrifugal, clockwise and counter-clockwise, inward and outward, refractive and diffractive, and conductive and inductive pairs of opposites, for which the mental equivalent is concentrative and decentrative. This is seemingly incredible, for each pair of opposites has a direction of ninety degrees from its axis of rotation. Each is the reaction of each other's action.

Always bear in mind our new law of the cycles which reads that **compression heats to cool and expansion cools to again heat**. Or it may be put this way: Cold generates heat and heat radiates heat to cold. This applies to the interchange between all pairs of opposites. For example, centripetal force compresses and centrifugal force expands to again compress--and, man works to rest and rests to again work. All of these pairs of opposites express their forces at angles of ninety degrees from their axes of rotation. Even man lies down to rest and stands upright to again work.

The concept of the expanding universe, without the power to generate an uphill flow of energy as well as to expand it into a heat-death, is untenable. We again repeat that science has been doing it everyday since laboratories began.

I believe this is a good place to break off this chapter and take a break. Thank you for your attention. I would like to write again today, please.

I AM --- GERMAIN

CHAPTER 2

REC #4 GERMAIN

WED., AUGUST 28, 1991 12:43 P.M. YEAR 5, DAY 012

EXPANDING UNIVERSE

The concept of the expanding universe grew out of the present belief that the universe was created eons ago by some cataclysmic effect that created a ball of heat which is now expanding into the presumed nothingness of space.

To say that the universe will "die" because THE LIGHT WHICH GOD IS will go out is equivalent to saying that God, its Creator, will die or will cease to think. You would not say of yourself that you will die if you cease to think. Or, in a more humorous vein--perhaps everyone in general, are already "dead" for we see very few signs of genuine "thinking". That concept is not worthy of intelligent, reasoning men.

In studying our diagrams, therefore, take special note of the fact that the axes of all waves which compress or generate are at ninety degree angles to those which expand or radiate.

THE COULOMB LAW

The Coulomb Law raises the most momentous questions of all time, questions which the greatest logicians of history have been unable to solve. Mathematics will not solve them with equations which are but assumptions. No human can solve that supreme mystery except one who KNOWS the Cosmic Source and CAUSE of ALL things.

It is a small wonder that Newton was deceived. His senses perceived that an apple fell **TO** the ground. He did not perceive that as the apple fell, its equal in potential arose simultaneously **FROM** the ground and sequentially the entire apple arose FROM the ground and its equal potential fell TO it.

The law reads as follows: **Like poles repel and unlike poles attract.**

Coulomb uses the term "magnetism" under the "ASSUMPTION" that this universe is an electromagnetic one, but that means "matter" which is the term used by Newton. **Both of them overlooked the vital fact that there is a zero of attraction and repulsion between stars or planets and between poles of a bar magnet. Astronauts find that zero position but they do not call it "magnetism"; they call it "GRAVITY" and that is what it is.** Iron filings will not adhere to the center of a bar magnet. Textbooks show that they will adhere only to the poles.

It seems as illogical for Coulomb to have assumed that the iron filings were **attracted** to the bar magnet--which should properly be termed a "gravity bar"--as it is for Newton to have assumed that the falling apple was **attracted** to earth. To have told either of them that both the apple and the filings were projected there by the force of compression exerted from the **outward toward the inward direction**, instead of **pulling inward from without**, would have been met with a blank stare and not listened to.

That is the right explanation of it, however, and it is our responsibility to explain it so clearly that any open-minded present-day scientist WILL SEE how consistently it fits into Nature's simple pattern.

A greater knowledge of the light-wave and its cycles is, therefore, necessary for we again say that the secrets of the universe lie within the wave. As light-waves have their nine-octave multiplying power to bring invisible light of negligible heat into visible intensely hot suns and nebulae, and as International Science is still unaware of that process, we are revealing it as our step-by-step way of completing our road map into space.

Heretofore we have said that the universe consists of THE UNDIVIDED UNIVERSE OF REST AND THE DIVIDED UNIVERSE OF MOTION. The first known Illuminate, the Krishna of the Bhagavad-Gita, used the term over and over again. It is not complete, however. It accounts for but half of the wave cycle. Heretofore in these writings we have not completed it because neither you nor Science were ready to receive it. Recent discoveries in world laboratories have indicated that Science is now ready for some new input for the ones who recognize the mechanisms have developed some pretty gross and spectacular things through this comprehension. Remember--truth of a scientific fact works for the just and the unjust and thus far, the higher technology has been thrust to deceit and delusion, destruction and the furthering of evil intent. It is time for Man to wake up and take control and return KNOWLEDGE into the LIGHTED INTENT.

There are some real "miracles" appearing to come forth from the laboratories and honest scientists who dare to speak out confirm the fact that this totally new Cosmogony is gradually being comprehended in scientific circles. It is a major reason WHY THE MEDIA AND PRESS HAD TO BE PLACED UNDER TOTAL CONTROL AND BE SILENCED.

The complete description of the wave is THE UNDIVIDED AND THE DIVIDED-MULTIPLIED UNIVERSE. This completes the cycle. The DIVIDED UNIVERSE accounts for but one swing of the cosmic pendulum. **It does not account for its countless repetitions which have given you a universe which had no beginnings and has no endings.**

This new two-way principle accounts for the simultaneous invisible swing of the pendulum from its zero of stillness to its compression focus and back again

through expansion. It also accounts for the voidance principle which makes of this universe an imagined one in which every happening anywhere is voided by its equal "unhappening" everywhere.

It accounts for the motion picture universe of illusion which many great thinkers have suggested as a probability for if the light of man's cinema were turned off, the sequential stills which constitute the illusion of motion would disappear. So, also, would the sequential waves of light of the Cosmic Cinema of the Creator's thinking disappear into blank space.

In thus closing the discussion of the Coulomb Law, I again repeat:

***EVERY ACTION-REACTION OF WAVE MOTION IS
VOIDED AS IT OCCURS, IS REPEATED AS IT IS
VOIDED, AND IS RECORDED AS IT IS REPEATED.***

SOLENOID COILS IMPROPERLY WOUND

Another failure of international science is not to have discovered that the solenoid coils of its research laboratories are improperly--therefore inefficiently--wound. Did Mr. Tesla realize this? Indeed he did and that is when the real thrust was made to get rid of him.

Not having discovered that the universe is an optical universe of gravity-controlled light instead of an electromagnetic one, it has wound its coils cylindrically instead of conically. Also, it has wound them without taking consideration of the collisions which necessitate opposite clockwise and counter-clockwise directions for each coil to create maximum gravity power without violating Nature's one direction. The diagram shows how they should be wound. (See Fig. 34)

Also, it has not discovered that there are four pairs of gravity poles on each gravity bar instead of only one pair at its ends. There MUST be in order to account for the octave multiplying-and-dividing power which the wave is created to fulfill. These four focal pairs are located on each side of its centering zero, the square of the distance from each other. They not only create the elements of compressed light and heat but also create the spectrum which is the measure of heat as well as being the sex and life principles of Creation. The two end zeros represent the inert gases of their octaves and the centering zero marks the collision point of maximum heat. The sun and all lesser matter are created and stepped up from cathodes to anodes. (See Fig. 29A)

The diagram (34, 34A & 35) tells how Nature winds its coils, all going around their axes in the same direction but each coil having a clockwise direction from one center and a counter-clockwise direction from the other. This accounts for an equator for the expansion ends, the cathodes of cold space, and another equator for the compression

ends, the anodes of hot suns. A little consideration given to this process of Nature will dispel any wonderment as to the source of the sun's energy and, also, it will account for the curvature of gravity in space. Note that Fig. 35 parallels the same effect in the union of the sexes.

It is an axiom of science that no more power can be taken from a generator than that which the generator puts into it. Let us consider this carefully. Any electrical engineer would reasonably ask WHY these solenoids give more power than your power plant puts into them. The answer goes back to the principle of the UNDIVIDED stillness and the pairs of opposites which comprise the DIVIDED universe in motion. Nature's suns are the result of maximum motion and maximum heat. Your planets do not receive that maximum heat of your suns. The heat which they receive has been divided by its radiation. If your Earth received the entire undivided heat, it would be equally as hot, and so would all of the other planets.

Your home power plants are the prototypes of your suns. In them is the maximum heat which the voltage of power used will give to them. That may be thousands of kilowatts. That power is divided into millions of lights and outlets in a town or city. If each of those lights and outlets received the full power of their generator, they would burn up as planets would do if they received the undivided broadly-distributed power received from their "town's generator".

The same principle applies to the power of a man. He, also, can give no more power to any task than he has received for building his body; that is true, but he does not give his full power to small tasks like opening an egg or polishing a window else he would destroy them. They also receive his much divided power. To lift one pound takes but a little of the power that is in him, but to lift a hundred and fifty pounds might take all of it.

Thus it is with the hundred outlets which are your house. You can take out of them only the divided power they receive from your home plant, but if you take ten of those outlets and connect them with a series of conical coils, you can heat a disc of steel to incandescence at their gravity centers with the coil itself while also creating heat units with the current at the anode points where the current collides.

In this manner, you have taken more heat from your current outlets than they have given to you.

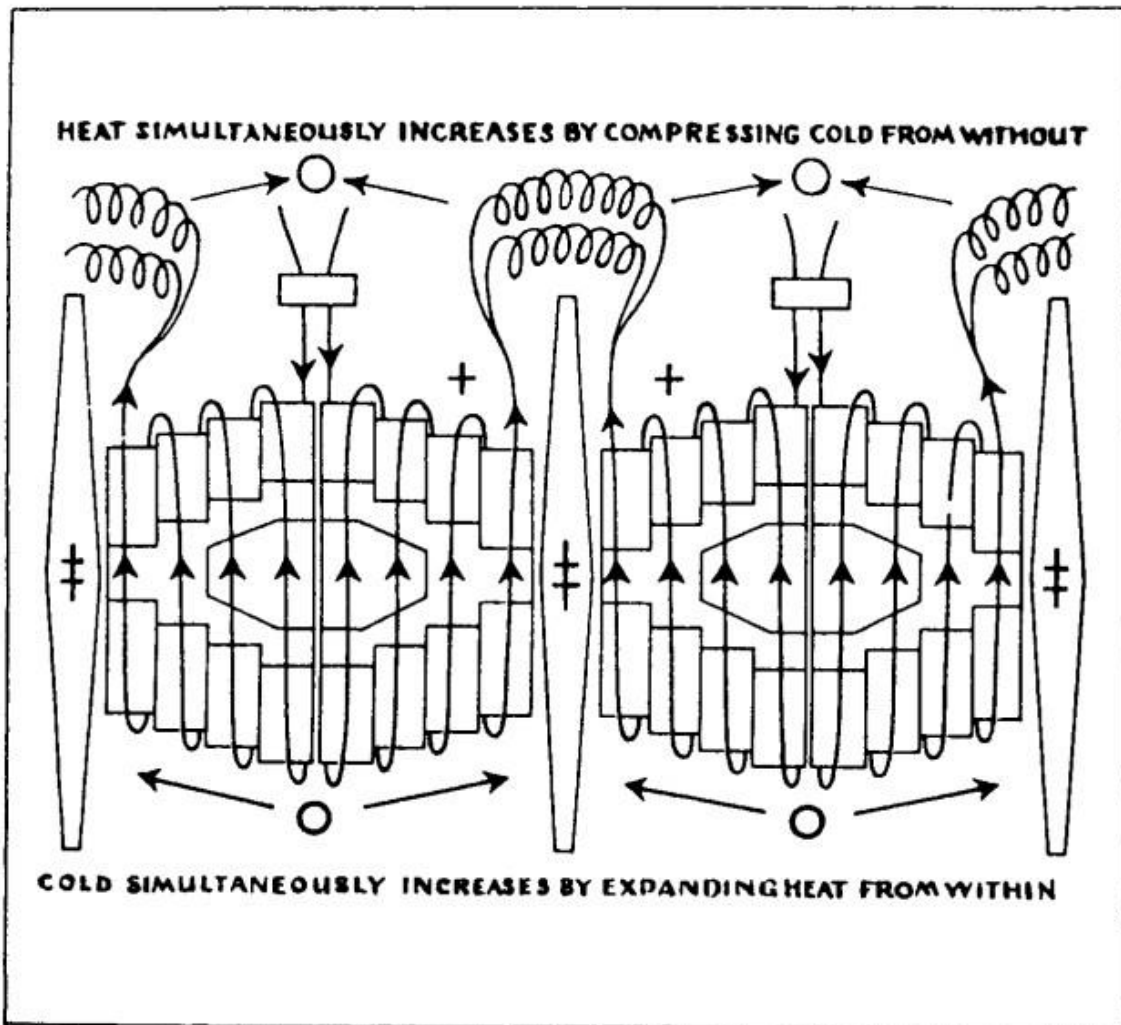

FIG. 34

This is to demonstrate Nature's way of winding her solenoids. She uses but one direction for compression and the same one for expansion, for compression thrusts inward from without and expansion thrusts outward from within. There is no force in Nature which pulls inward from within. Gravity accounts for that force. Therefore, Newton was in error when he said that gravity pulls inward from within.

Note that the steel core is conical. Power multiplies that way. Also note that the wiring divides in the middle of the coil and increases its turns in the direction of compression. Gravity heats that way. That is the way suns come into being. That is the way anodes multiply from cathodes. From anodes to cathode zeros, the direction is counter-clockwise and from cathodes to anodes, the direction is clockwise as it is in suns and planets.

By omitting the centering units, power can be generated for heat and light in homes and cities. By including them, they will become incandescent and that gravity heat could be enclosed in a boiler to which heat units would also be attached and thus become a reactor as powerful as an atomic reactor, according to the number of coils used, in series, by leading to a steam turbine. Atomic reactors could then make use of this principle and without the danger of using atomic power.

THE SPIRALING THOUGHT/LIGHT WAVES OF CREATION REVOLVE AROUND THE ZERO STILLNESS (GRAVITY) CENTERING, CONTROLLING, BALANCING. THE FORCE OF GRAVITY IS BY COMPRESSION TOWARD THE INSIDE FROM THE OUTSIDE NOT BY PULLING FROM WITHIN.

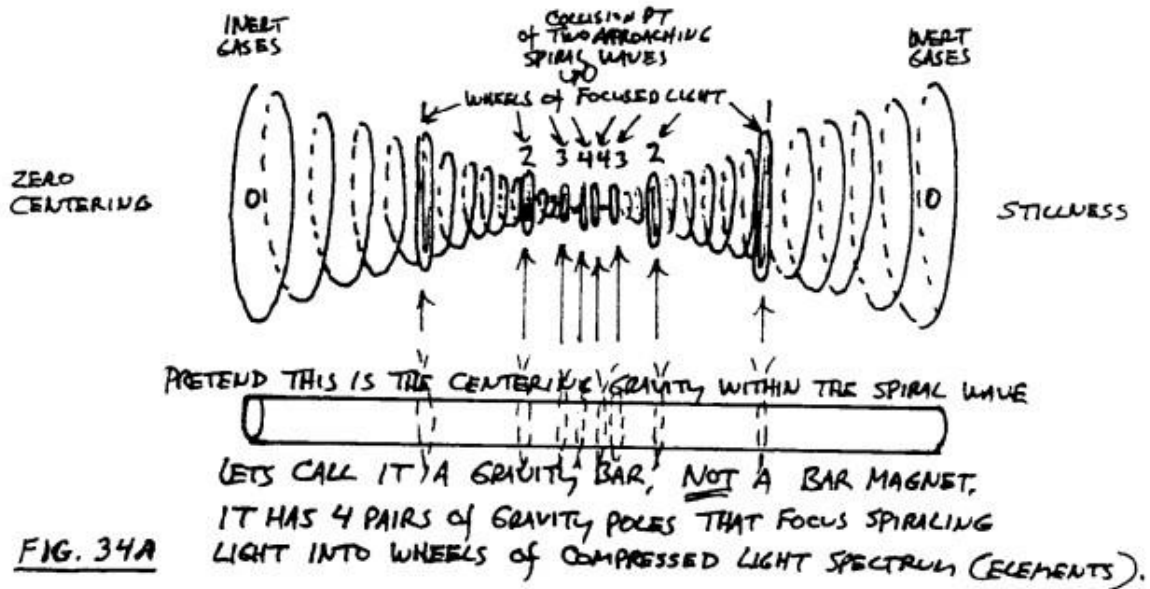

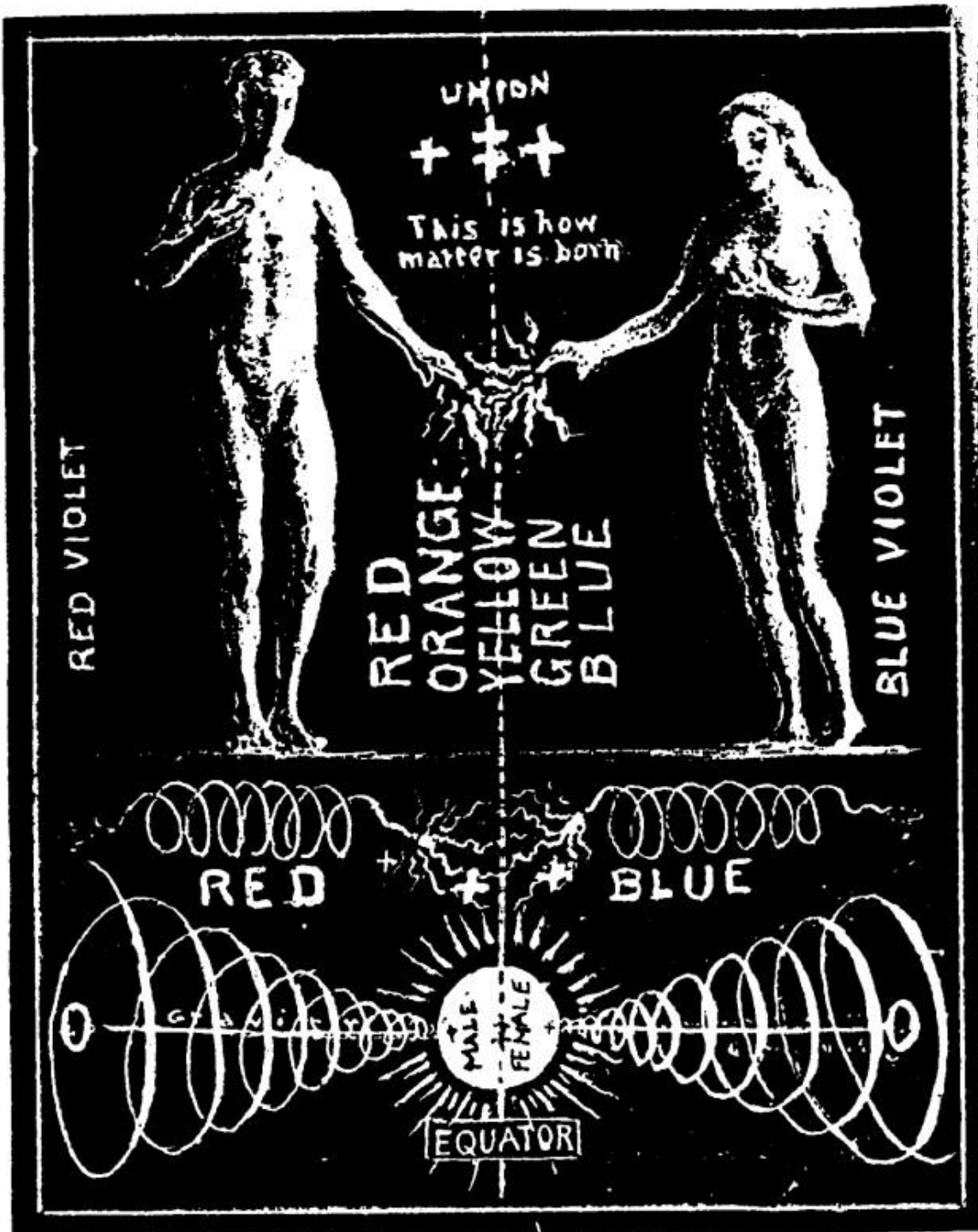
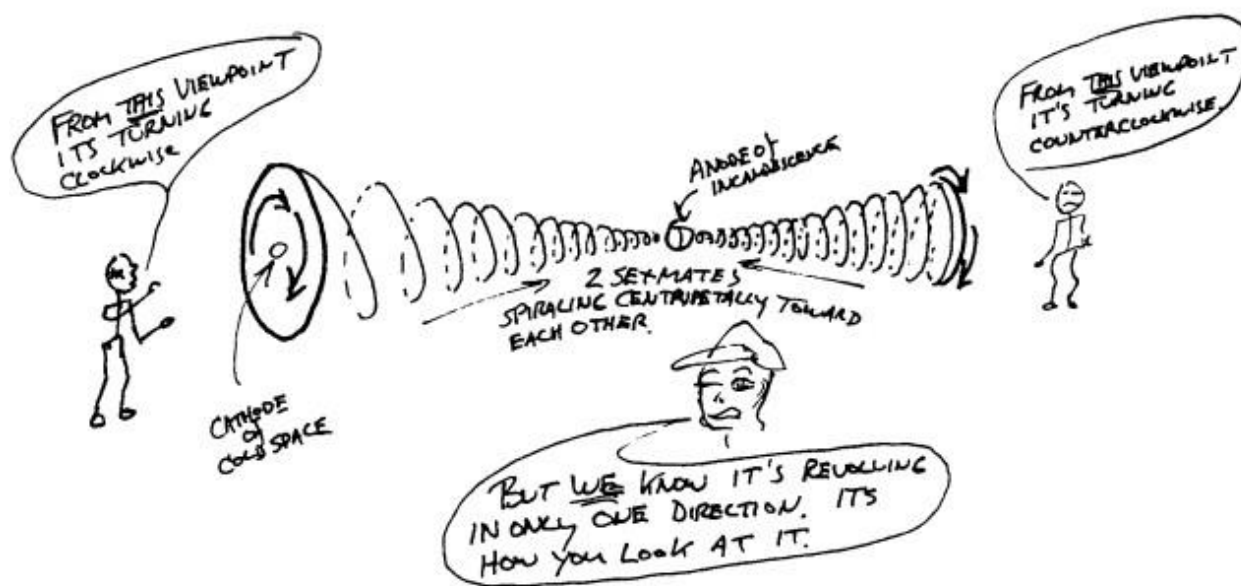

FIG. 35

This illustrates the parallel effect of the properly wound solenoid coil in the sex principle of Nature. It also indicates its relation to the spectrum of the sun in which the white-centered yellows divide the red and blue sides of the sun.



A PAIR OF OPPOSITES EXTENDING TOWARD EACH OTHER FROM THE UNDIVIDED STILLNESS,

Fig 35A

RUTHERFORD-BOHR THEORY OF ATOMIC STRUCTURE

Let us look at this theory for as we conclude this lesson we need to question the validity of that Rutherford-Bohr theory of atomic structure.

The preceding pages picture a consistent universe of interchanging swings of the cosmic pendulum which have no resemblance to the familiar diagram which we print here. (See Fig. 36)

Allow us to question this theory. It claims that every atom has a nucleus which is held together by some mysterious "glue", but no scientist has yet discovered what that "glue" is. Every scientist does know, however, that a compression pump will not only produce heat but will hold it together as one mass, and that a vacuum pump will take the heat out of it and produce cold.

Why search any longer for that "glue" for **compression** lies at the end of that useless search? Science also claims that its nuclei are surrounded by various layers of electrons which revolve around them in certain mathematical layers in planes which do not parallel the equator of its nucleus. Nature gives no precedent for such a peculiar action. Suns and planets are surrounded solely by rings which revolve around their equators. These rings wind up into planets which gradually leave their planes of birth, as the outer planets beyond Mercury have done and as Mercury will also do. They still revolve around their centering suns but in an outward direction and not at fixed levels.

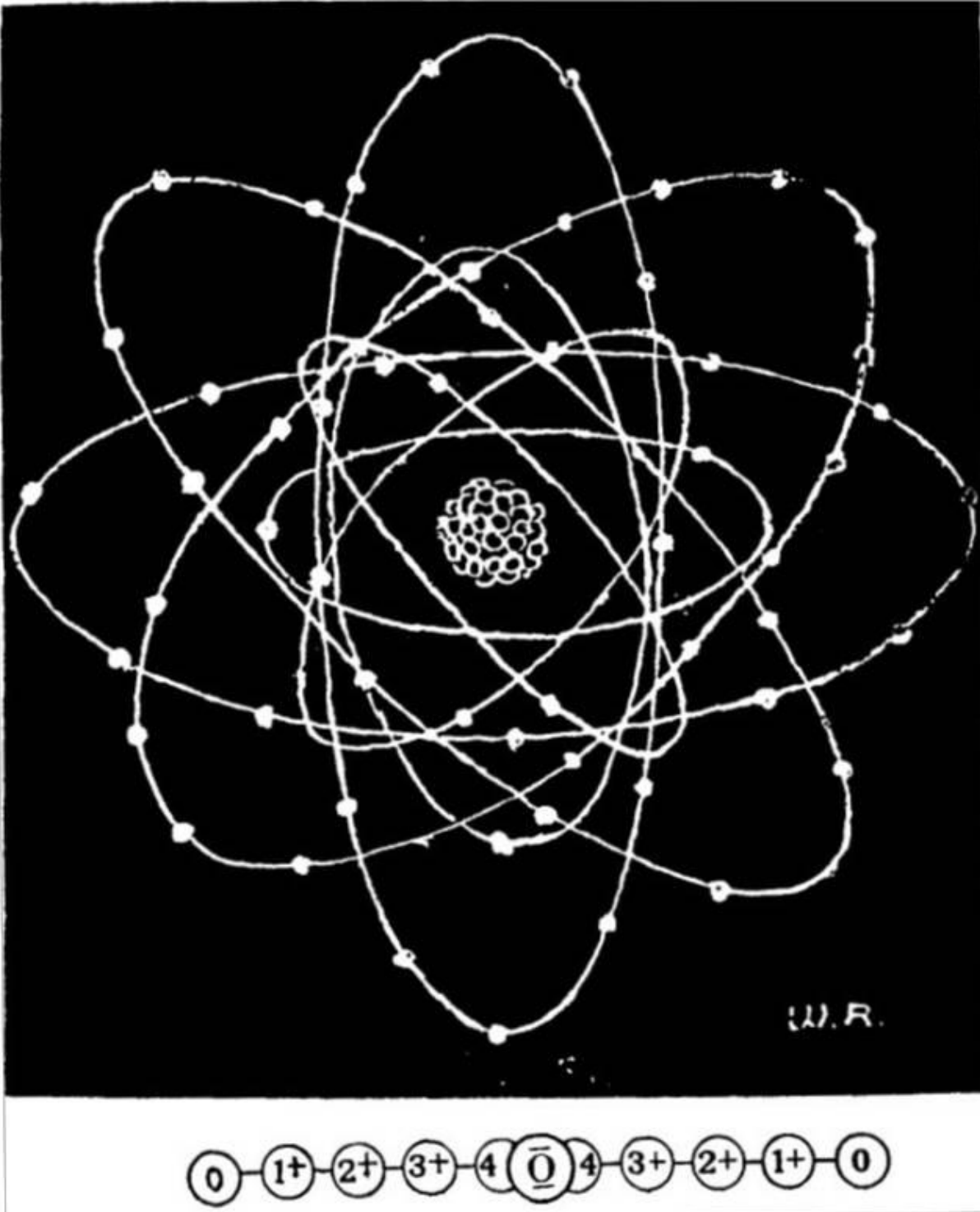

Nature has no precedent for that action for all motion is spiral. The directional movement of all planets is centrifugal.

If Science really knew what electrons are, it would not sustain that theory for one second. When we discuss the "Russell" new chart of the elements, we will tell what they are and this will greatly help science in the work on electronics. Suffice it for here

to say that electrons do not revolve in orbits around any nucleus. In fact, they do not have a nucleus. They spring from the zero inert gases of their octave toward a nucleus in the first element of their fourth octave--as lithium springs from helium--then multiply in cube ratio at each step toward carbon.

Science has already found such a particle which acts like an electron but is two hundred times more powerful. Further discussion about it is useless at this point for if the foregoing is not sufficiently convincing, then further consideration would not aid it but compound the incomprehension.

NEW LAWS OF THERMODYNAMICS

As we move along into the new laws of thermodynamics I am going to give respect and reverence to the man who penned them to paper for you ones. It was Walter Russell and he received them directly from me as I now write--except that his was a comprehension capacity and not simply as a translator of the information. Some of you will read this and say, "Well, then its hardly 'new' because Russell is long dead." How many of you understand them from the time Russell shared them as he brought them forth for you? I thought so--hardly anyone! Your world would have already been turned about and headed toward God if you had understood. Most of you readers will have never even HEARD OF RUSSELL except through these writings or in research from these writings. Ah 'tis indeed sad for these men came forth out of their time--to test the readiness; and have always found it lacking--I hope it happens not this time also, for your sequence of events precludes further "dragging" opportunities. NOW IS THE TIME, HUMAN BROTHERS--IT IS "MAKE IT" OR "BREAK IT" TIME.

In the last lesson, we stated that a distinguished scientist said that he believed you would soon learn how to control gravity from which marvelous results would follow. I also relayed that science has already been able to control gravity for a long time but does not know that it has done so. Let us consider this by giving a few examples.

One conspicuous example is the projection of satellites into gravity-free orbits around the Earth. More conspicuous still is the demonstrated fact that astronauts can accompany those satellites and reduce their speed at will in order to lower them to the ground where ground forces can control their areas of landing. The very fact of ground crews knowing where they are at all times is another conquest of gravity. To be able to talk to them from thousands of miles away is still another conquest for, heretofore, man has been able to talk to others only by wire until radio, television and radar had been discovered. I use this example for these are what you-the-public are allowed to see and know. There are incredible things which are hidden intentionally from you and yet there is no use utilizing those things as example for you have nothing with which to relate the information.

This all grew from the conquest of gravity by the airplane itself. Such a miracle would have been considered an impossibility during the end of the last century. A familiar

quotation then was: "You could no more do that than you could fly." This phrase would seem strange to the coming generation.

What greater miracle in the conquest of gravity could be thought of by man than the power to hurl rockets and explosive missiles thousands of miles into space and to control the spot on the other side of the earth, or across its poles, upon which their projectors desire them to land? Equally great is the power of an adversary to meet those missiles, which they can find in mid-air at great distances from their point of projection, with others.

This is already such mundane capability that it becomes totally ridiculous that you-the-public would buy into such lies as that which happened in Iraq. Right now there is pictured an installation of the giant "Bull" cannon in Iraq which takes up the entire side of a hill--openly visible. How is it that mosques were hit, dwellings and shelters--and the nuclear installations and such as the Bull cannon were not touched???

America, alone, has satellite capability set up for control of you by the Bankers (called the Star Wars Defense System) which allows for reading a business card of a specific person from orbit. The same for audio signals--so guess WHO IS FOOLING WHO!

The conquest of gravity by liquefying gases, even to inert gases, is still another seeming impossibility for it is a reversal of Nature's process of heating, even as the freezing of soft metals to harder ones of greater conductivity is further evidence of the increasing power of the Mind of man.

Even the ability to create the fuels which hurl these missiles and satellites is another one of man's miracles. It is also a transmutation process for it divides the very elements to get that part of them which serves their purpose and discards the other parts.

As a last example of the many uses which could be cited of gravity control is the power of science to take from the high octave elements, such as zirconium which gravity has multiplied by its compression power, and make them into transistors. These do thousands of times as much as the old "electric" storage batteries do, but no scientist would think of GRAVITY as being its CAUSE. This is because science thinks of gravity in the Newtonian concept. Manufacturers of computers have been enabled to do great things with gravity and simplify their machines because of it. They, too, however, are unaware of the true nature of gravity.

Up to a century ago, man had not begun to make any conspicuous use of the power to control gravity. God alone had that power. When the steam engine was invented, that God-power began to multiply in man. That is what God intends for man who was created to manifest his Creator on Earth. **God's highest goal for man is his own omnipotence and omniscience. Man already has God's omnipresence, for his every thought and action extend to the farthestmost star and end in himself. That includes their unity with every other human on Earth--and this spells out the brotherhood-of-man relationship.**

The tragedy of present-day humanity is that mankind is not aware of its power nor of its real Source, for if it were aware of these things man could not possibly slaughter other men in his barbarous unholy wars.

NEW LAWS

This will deal with that which we will simply refer to henceforth as Russell's New Laws of Thermodynamics. Past lessons, and especially the just prior one, have very plainly explained the Creator's process of causing a visible universe of hot light of suns and stars to appear from the inconceivably cold light of space and then to disappear into it or, as man describes it, to be swallowed up by it, yet man has never yet been able to discover that process.

The main reason for that failure is that his concept of the creation of the visible light universe is that it was created out of some cataclysmic happening in the universe which resulted in a great ball of fire. Believing this, he reasons that that ball of fire will gradually cool by splitting up into smaller balls of fire. That belief is the basis of his theory that energy lies in matter itself and of the expanding universe which will cause the eventual death of the universe. The name given to that cosmic death is ENTROPY.

Out of that same concept of the birth of Creation grew the belief that energy cannot run uphill but only downhill. To formulate that into a system, the first and second laws of thermodynamics were formed, with emphasis on the second.

It is very strange that such a code of laws could ever have been written or followed as sacrosanct by modern science in view of the fact that every laboratory on Earth is today making energy run uphill by multiplying the stillness of fifteen pounds pressure per square inch to thousands of pounds pressure by compressing room temperature to an incandescence which can melt the hardest steel into vapors in a few seconds.

Let me quote what one, Sir Oliver Lodge, says about it in his book entitled "Energy":

"Sir William Thompson, our great authority, found it difficult to realize that in a steam engine the heat not only fell down in temperature from boiler to condenser . . . but that, unlike water, heat was actually consumed in the process, so that less heat was given to the condenser than was taken from the boiler."

Of course it was, for the heat expanded into cold in the process to again heat by compression, like rain becoming compressed from hot vapors by falling into the sea.

I continue the quote:

"That is not so in a hydraulic engine, nor in an electric; just as much electricity flows away from a motor as flows to it. The work is done at the expense of the

drop in voltage. But heat engines . . . were exception. Heat not only fell in temperature but was actually consumed and turned into other forms of energy."

Of course the voltage will drop. The heat turns into cold which generates heat by compressing it. We again quote our new law of the cycles which makes the universe of motion continuous. **Cold generates, generation heats, heat radiates and radiation cools.** Each is the reaction of each other's action. Each gives birth to its opposite mate. Life begets death and death begets life. Inbreathing forces an outbreathing.

To continue the quoting:

"This is now sometimes called the First Law of Thermodynamics, which is a definite assertion that heat is energy. . . . Work can only be done by passing or transferring energy from something at high level or potential or temperature to something else at lower level or potential or temperature. So to a hydraulic engineer all the water in the sea is useless, for it is all at the same level. The fact that water tends to run downhill and reach the sea is an example of the dissipation of available energy. It may do work on the journey, but the ultimate result is stagnation. The fact that bodies actually cool, or in other words that heat tends to flow down from high temperature to low, is another example. . . ."

This is not in accord with Natural Law. The new Laws of Thermodynamics fully contradict this reasoning.

We again quote a conspicuous untruth from Lodge's "The Ether of Space":

"Light is an electromagnetic disturbance. Optics is a branch of electricity."

That is not in accord with Natural Law. LIGHT is the ONE THING which constitutes Creation. The fact that man can produce visible light by shortening the long waves of invisible light through resisting its flow, as a meteorite does, or by the friction of a dynamo wheel or a solenoid coil, or even by shuffling his feet upon a carpet and touching metal, does not warrant man to conclude that he created light. All of the consummate Illuminates such as the Krishna of the Bhagavad-Gita, Immanuel and Buddha have told you that GOD IS LIGHT. To presume that man has created Light by his own activities is to claim that he has Created God.

If optics is a branch of electricity, it is strange that no book on optics that you have around, ever makes any mention of electricity as being its basis. **Optics itself makes one conspicuous mistake, and it is a most serious one because it misleads one as to the nature of light.** It constantly speaks of, and diagrams, PARALLEL rays of light.

THERE ARE NO PARALLEL RAYS OF LIGHT IN THE WHOLE UNIVERSE. THEY EITHER DIVERGE OR CONVERGE.

Look about you in your own room at night. Every light in it sends curved diverging rays which converge in every other light. Look down from a plane onto cities and separating meadows. You see the prototypes of stars and star clusters in which high potential short waves lead to low potential long waves in curved rays which converge in every other light in the universe in the same manner. That is God's way of intercommunicating and recording the actions and reactions of interchanging pairs of opposites in His universe. And that is man's way, also, of multiplying space silence into audible sound by his radar system. In fact, the multiplication of silence into sound parallels man's multiplication of invisible light into visible light. **Both light and silence are eternal and basic, while visible light and sound are transient repetitions.**

In spite of the above refuting facts, Lodge in the same book says:

"Not yet do we realize what we are doing. Not yet have we any dynamical theory of electric currents, of static charges, and of magnetism. Not yet, indeed, have we any dynamical theory of light. . . . And when the present century, or the century after, lets us deeper into their secrets, and the secrets of other phenomena now in the course of being investigated, I feel that it will be no merely material prospect that will be opening on our view, but some glimpse into a region of the universe which Science has never entered yet, but which has been sought from afar, **and perhaps blindly apprehended, by painter and poet, by philosopher and saint**"
(Emphasis added)

This prophesy is already unfolded. Strangely enough, by ones who do not proclaim to be scientists. Scientists seem to only take that which another scientist proclaims and furthers the lie. Who is there, therefore, who dares say that this knowledge can only come from books and teachings of men whose concepts are forever changing, and whose teachings have likewise changed, from the flat-world concepts to the Ptolemy, Copernicus, Newton, Faraday, Tesla and Rutherford-Bohr concepts?

THE LAWS

- 1. Cold generates energy. Heat radiates energy. Cold multiplies. It cannot divide for it is the fulcrum of the universe which must extend to multiply. Heat divides. It cannot multiply but can be multiplied.**
- 2. Every action must be preceded and followed by its equal and opposite reaction. Heat is the reaction of cold. Heat could not come into being save for the compressive action of cold, nor could it repeat itself without losing itself in basic cold.**

3. Cold is static, unchanging and unconditioned. It eternally lives. Cold light is the basic ONE THING of this universe. Heat waves are dynamic, forever changing and dually conditioned. They are eternally living and dying to simulate life.

4. Cold light is the omnipresent basis of universal intelligence and energy. Hot waves of light, which man calls matter, are a simulation of intelligence and energy. There is no intelligence or energy in matter.

5. Static cold and dynamic heat express their opposite energies at angles of ninety degrees from their axes of rotation. Cold retains its static, motionless condition along wave axes where motion ceases at points of maximum heat, while heat extends along equators to again expand as cold. This balanced interchanging completes the wave cycle.

6. Cold compresses. Cold multiplies cold to create heat. Heat expands to divide heat into cold. Varied pressures of heat constitute the octave color spectrum cycles and the octave chemical cycles of matter. Their varied wave lengths are the basis of your mathematics.

7. Long low waves of low potential and high frequencies constitute the invisible spectrum and low density gases while short high waves of high potential and low frequencies constitute the basis for high density.

It is our hope that deep consideration of the consistency of these laws will point out to all workers in science the fact that the old laws have actually been but words to them and become a habit like deep-seated tradition, for they have not followed them in their laboratory practices.

Let us leave this portion for I ask that you review until you memorize, the preceding laws for we shall be expanding on them. When we pen again we shall consider SOUND AND SILENCE.

Thank you.

I AM --- GERMAIN

CHAPTER 3

REC #2 GERMAIN

THUR., AUGUST 29, 1991 11:03 A.M. YEAR 5, DAY 013

THURSDAY, AUGUST 29, 1991

Germain present and I know you don't want to do this tedious work, so, we shall whip right on through it so you can get back to playing in the James Bond game. The facts are, however, that if you don't get these lessons learned--there isn't going to be a very successful "lift-off" of anyone in a nice "live" format. As the "Earth" games get more and more focused on the adversary's part--the more important it becomes for you ones to learn how the system REALLY works if you are to have any "chance" against the incredible wave of evil oversweeping your planet. That means we have to move smartly along with our work. I think the following example of attitudes is sufficient to allow you to have relative discernment--ours is to bring full TRUTH--the attitude of your adversary is deceit and lies, even if truth would serve his need better. A statement greatly publicized a while back and presented as standard operating procedure and introduced into Congress, is as follows: *Former Asst. Secretary of Defense, Arthur Sylvester: "IT IS INHERENT IN GOVERNMENT'S RIGHT, IF NECESSARY, TO LIE.... THAT SEEMS TO ME BASIC--BASIC."* So be it!

What you are being shown and told about what is happening in the Soviet Union this day--is almost all lies. You are getting a total presentation of LIES so that you WILL NOT KNOW THE FACTS--IT IS MORE HEINOUSLY COVERED THAN WAS THE IRAQ INFORMATION BLITZ--THAT, IN FACT, WAS A RUN-THROUGH TO SEE HOW MUCH THE CITIZENS OF THE WORLD AND THE MEDIA/PRESS WOULD TOLERATE IN LIES--AND YOU SWALLOWED IT ALL! GOOD LUCK--WORLD!

Let us move on, Dharma.

SOUND AND SILENCE

We now desire to bring into the scope of man's thinking a new idea which has not yet entered human consciousness. Science has not been ready for this new knowledge because the old thermodynamic laws gave it no ground to stand upon. This idea of sound and silence is appropriate at this point in our narration because it parallels the new dynamic laws.

It will strike one as strange to think of sound and silence in terms of compression and expansion, heat and cold, and other such cycles of opposites and interchanges of pulsations, but they are just that.

Sound is not a thing which just **happens**; it is made to happen. **Just as cold is the fulcrum upon which its heat extends so, also, is silence the fulcrum upon which sound extends. Likewise, just as heat appears from cold and disappears into it, sound appears from silence and is "swallowed up" by it.**

This fact would not be of great import to science were it not for the greater fact that the speed pulsations repeat themselves while the spreading of their waves is conspicuously slower than the speed of incandescent light. This is of special significance to research workers in radar and electronics, for radar is possible only when the speed of sound in such a moving body as a bomber plane can be amplified sufficiently to detect it electronically. The very manner in which electrons do this is another principle of great importance for research workers to know. This we will explain later while describing the nine octave chart of Nature's step-up and step-down process of creating this universe. (See Page 43, Fig.68.)

A man can see a flash of light from a pistol shot long seconds before he can hear the sound of it. The same is true of a flash of lightning. In the meantime, the speeds of light and sound have girdled the world many times. The reason for this is of great importance for science to comprehend, for up to this date no textbook on physics has given it. We will now give it.

The reason begins with the question which asks what light and sound are.

Both light and sound are the repercussions resulting from the collision of any two or more objects or forces. Wave pulsations constitute a force of compression in fulfilling their process of creating matter. Every collision of a wave gives forth a sound when it reaches its amplitude anode. It also gives forth light and heat. This may come as a surprise to science but it is true. It is also true at the ninth, or plutonium octave, where it explodes and ceases to traverse the universe by spreading out and returning to its zero of silence and the cold of space.

In other words, light and sound live and die as all effects of wave motions live and die. Even the sounds of the most violent explosions spread out and gradually die, just as man and all transient life likewise do. We say that sound travels at a fixed speed which we call the sonic level. It does, but how far does it spread? The man who hears a pistol shot at close range hears it louder than the man who is half a mile away. The ear-shaking sound of thunder heard in one county cannot be heard in the next county unless the receiver is near the adjoining border in separation distance.

The heat and light emitted from a rod of iron on your electric stove will likewise die, whereas incandescent light from a very thin tungsten filament will spread throughout the universe at the speed of light--which is 186,400 miles per second--and return to the very spot from which it began as its reaction. At that very point of its final explosion, it has fulfilled its purpose of telling the world of its universal Oneness.

Thus ends the expression of God's omnipotence as evidenced by photosynthetic waves of light, controlled by GRAVITY, God's sole workers in the creation of the curved universe of our Creator's imagining.

PHOTOSYNTHESIS AND THE GEOMETRY OF SPACE

It is commonplace knowledge that everything which comes out of the earth, both vegetable and animal, issues from seed. You know that the fathers of man place their seed in the mothers to produce both fathers and mothers of the human race. So it is, also, with animal life. In vegetable life, the seed is inserted in other ways such as pollen being carried by bees from one flower to another, but you do not refer to that process as being the work of fathers and mothers due to the failure of science to give recognition to the fact that the DIVIDED universe of pairs of opposites, which issues from the zero UNDIVIDED stillness of space, is the sex principle of all Creation.

The sex principle is the most basic fact of Creation.

It may be that the inability to recognize the sex principle in the mineral world was the stumbling block which caused that to happen. We say to you, however, that the mineral kingdom also comes into existence through the seed of fathers and mothers interchanging.

The underlying secret of all seeds is that their basis is the inert gases which are in the zero column of the periodic table of the elements of matter.

It will be noted that the vegetable kingdom varies in its densities. The tubular variety of soft vegetables is of low potential, and the harder ones like the oak are higher in potential. Even these vary. The poplar is softer and will grow more quickly than the mahogany and ebony.

Invisible gases also have fathers and mothers. These are of still lower potential, for they issue from the unknown and uncharted inert gases below helium. The Russell charts show these gases. They have been given prior to this but should be entered into these last books also for quick reference.

It is commonplace knowledge that all vegetable and animal life unfold from their seed and return into it. Everyone is familiar with the many acorns of the oak, the many seeds of the maple, the flower and of man himself, **but he is not familiar with the fact that every gas and mineral, likewise, refolds into its inert gas-based seed. They all do, however. To prove it, pass a high voltage current through a tungsten filament enclosed in an electric bulb or, better still, through an evacuated tube. The residue will be helium.**

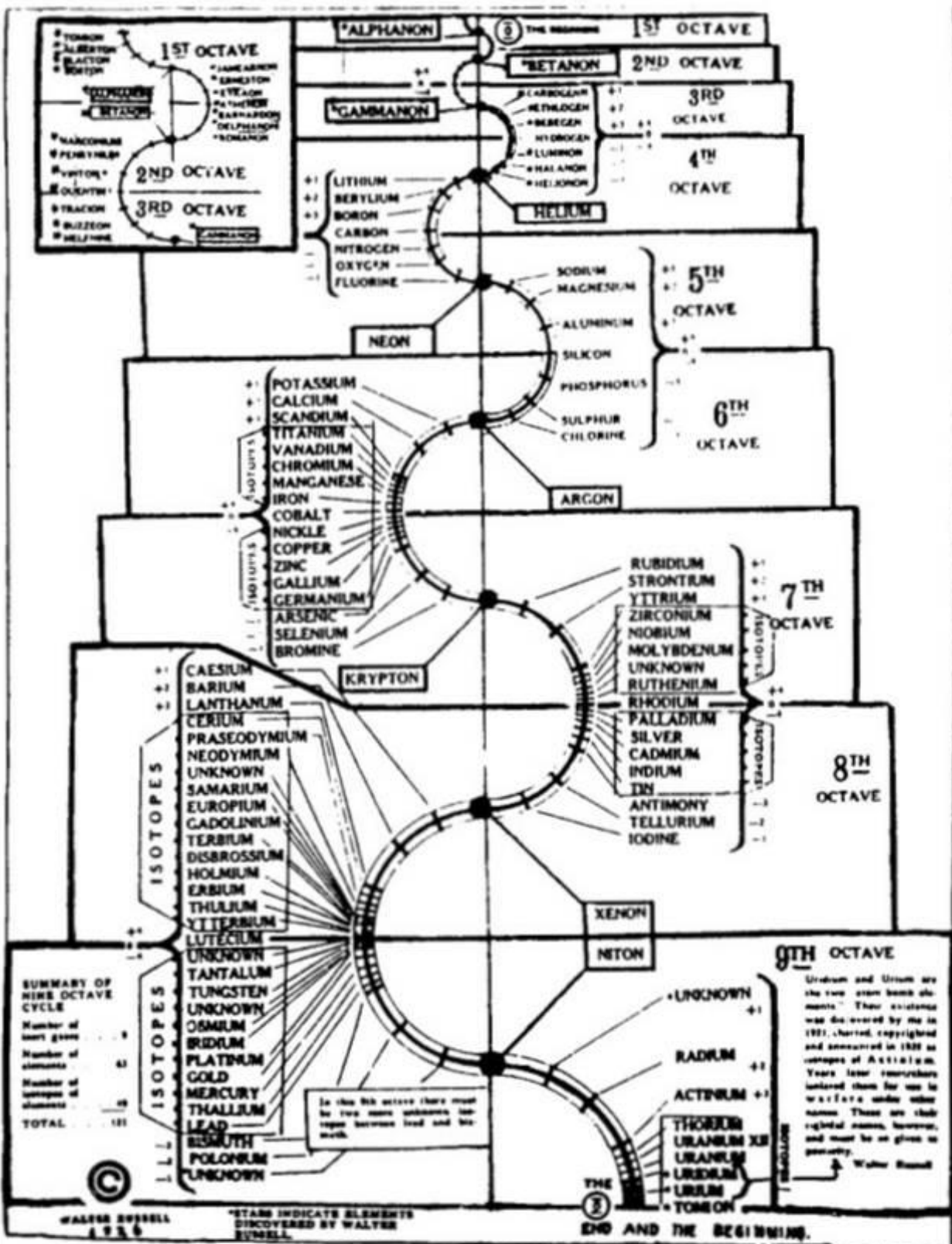

FIG. 68 The Russell Periodic Chart of the Elements, No. 1

One of the two completed Mendeleef tables of the elements which Walter Russell gave to the world of science in 1926.

THE INERT GASES ARE THE "HEAVEN" TO WHICH ALL THINGS RETURN WHEN THEY DIE! ALL THINGS!

There are nine of these inert gases. They step up their potentials in mathematical ratios from the first to the ninth. The tubular varieties issue from the first of these. In them, densities increase in the outward direction by pressures exerted within. They correspond to the rings of light heretofore described as cyclonic centripetal vortices. The solids issue from the inert gases of higher potential in which the holes are closed. In these, densities increase inwardly, like the oak or ebony, by pressures exerted inwardly from the outside, corresponding with the solid metals and minerals like carbon, iron or quartz, or even such liquids as water.

All of this goes to show the simplicity of this new science, for all effects of motion follow the same pattern and principle. All effects parallel each other in their construction. They all multiply cold and divide heat. (This principle is demonstrated in the New Laws of Thermodynamics.)

This process of Nature constitutes the principle of photosynthesis, the process of growth and decay of all matter and all life on Earth and in the whole universe. It is God's bookkeeping system. It faithfully records every thought and every action of every growing thing on Earth and photographs them in the seed of those unfolding-refolding things by that process which is called life and death.

The familiar phrase which reads, "*As you think, so you become,*" **IS NOT QUITE TRUE.** A man may think great thoughts and not become what he thinks. Neither will his children. The phrase should read, "**As you do, so you become!**" **YOU** are the result of your decisions. If you do what you think, you will also build a better body to do those things. And the better you build your body, the better it will be enabled to fulfill your desires, for desire is the basis of all motion by you or the universe.

"Desire ye what ye will and, behold, it standeth before thee!" BUT, it further demands that you use your strong right arm to fulfill your desire, as exemplified in the message of "God will work **WITH** you but not **FOR** you." It is in this manner that you fulfill your own destiny, your own identity.

It is desire which gives you the kind of body you **NEED** to fulfill your destiny. A musician would not desire to build the body of a pugilist; neither would a runner or skater. **Desire is the basis of the healing principle, for desire for normalcy will give you a normal body if you do the things which fulfill your desire.**

At this point I must go over a personal note with Dharma and the ones who serve in proximity. All witnessed Dharma undergo 32 days of full fasting and 52 days with nothing added but 8 ounces of protein--she lost only about 30 pounds and never lost the "thickness" around the solar plexus. We have explained this at length with her--but it is difficult for a lovely lady to "get out of shape" according to her wardrobe and personal expectations of self. BUT, this lady made that choice when she sat to work at

this electronic device--to allow what she refers to as fat to accumulate. With her we have to keep it around the mid-section because that is where the attacks come from the electronic pulses--in the upper torso. Those beams do not travel well through, (ooh, I have to use the word, chela--fat!) So, no matter what this one does to "lose weight and bulges"--she will not. We will not allow it even if she gets really intent about it. When we finish the heavy load of scribing and relieve her of these multitudes of hours under bombardment--we will give her instant change. Until then she has offered to make that "sacrifice" in behalf of service. I think it is no more difficult to perceive than an actor "fitting" a role need.

Let us, however, look at the extreme of that projection--obesity is very, very hard on the physical operation of a body. And unless you have good excuse of working in the firing line of the CIA--don't use the same excuse we allow Dharma. Know, though, that any deviation from "normal" presentation of a body--is not due to physical malfunction, but rather, to mental malfunction in almost every case. Moderate overweight is perfectly healthy--more than depletion by efforts to retain skeletal presentation--for the body, especially of the female, is directed to be soft and round and feminine. The image of skin and bones as on the models is a thrust to destroy you by emotional hate of self and sell products. It is not "normal" to be exceptionally thin--but rather, "balanced". It is another way for the adversary to cause unrest, unbalance and character assassination of self.

On the above, "to sell products", it moves the whole gambit from that which you wear to that which is required to keep you in a state of physical unbalance, and you all fall for all of it--from the exercise wardens to the potato chip manufacturers. If you did away with the government and physical "change" industry the world would totally collapse, I suspect--without doing anything additional.

A healthy body does one thing--serves only one purpose in intent--IT ALLOWS THE MIND TO FUNCTION WITHOUT FOCUS ON THE MECHANICAL MACHINE. For example--it is hard to type with a broken finger! I don't have much patience with Dharma's impatience, however, for a 60 year-old grandma can stand to have a thick waist for a couple of years without complaint!

Please, all of you, as you come into understanding--please try to use balance and REASON in your understanding for you have been people of the lie for such a very long time.

Allow nature to help fit your NEEDS and that which you do for service and purpose. Even in the vegetable kingdom, which presumably does not "think", desire is the basis of its own growth--according to purpose. A "skin and bones" pumpkin is hardly desirable, neither is a fat, pithy radish--USE REASON AND BALANCE!

It is more complicated than the above, of course, but not very much. We again repeat that **desire** is in the seed. An oak or pine tree on the coast at Bar Harbor may not "think" but it becomes more sturdy than one a mile away from it in the flatlands or in

mid-California. **Desire** to resist the winds awakens that desire to resist them, for **gravity** gives to all things the will to survive. Mind centers all things; therefore, mentality affects all things. Dharma has to decide whether she will serve "alive" and wear a size 16 or withdraw service as our scribe and wear her size 10's. Now I think we might have better perspective?? No, you cannot have BOTH, chela. YOU cannot--we need the security and safety of your being and if it requires additional wardrobe to suit the change--get it and stop the grumbling, the clothes can always be taken-in when we finish the heavy load of writing. Do I make myself sufficiently clear?

In thus defining the optical process of photosynthesis as the **gravity-controlled** universe, we trust you can now see that the term "electromagnetic universe" is not in accord with Natural Law.

Take a break please and we will pick up with the geometry of space, when you return--there are other things that need your attention right now. Thank you.

THURSDAY, AUGUST 29, 1991, 2:19 P.M.--CONTINUATION

THE GEOMETRY OF SPACE

Every orderly system must have an orderly basis for its construction, whether it be a little house or a skyscraper, one planet of a solar system or the whole universe of countless solar systems. **As LIGHT is the ONE THING of this universe, and the science of light is optics, the construction of the universe is not based on what the textbooks on optics tell you nor upon what the textbooks on electricity and magnetism tell you.**

The Creator makes use of but two opposite curvatures of light waves as tools for creating this entire universe of visible light. With these two curved tools only, the centripetal spirals which compress light into heat and the centrifugal spirals which expand it into cold are created. (See Fig. 37)

Figure 37 demonstrates the love principle of rhythmic balanced interchange which the curved universe eternally repeats. To progress the idea still further in our step-by-step descriptive process, we print another diagram which shows how Nature arranges its lenses. Fig.38 is a diagram of the sun or planet or any truly spherical body. There are nine lenses, each one performing its own separate purpose.

Study Figure 38 as we describe it. The two polar lenses are located at the blue ends of the spectrum where heat is minimum. These are known in textbooks on optics as biconvex lenses. These lenses project light toward a mutual focal center and perform the work of compressing cold invisible light into hot visible light of varying intensities from the **outside inward**. The central lens is **biconcave**. It is located in the yellow and white ends of the spectrum where incandescence is maximum. The other six lenses are known in optics as **double meniscus** lenses. All of these seven centering lenses project

light outward from within, and inward from without, to create the rings and spirals which you see upon the line of the equator.

Now take special note of the two lower lens diagrams and you will better visualize how the centering seven lenses in the two drawings marked A and B gradually become thinner as the suns lose their true spherical shapes and begin to oblate. This can be plainly identified in our planets. Our sun itself will begin its death process in the same way and develop increasingly great holes in it which will grow bigger and bigger until it reaches the stage you see in the drawing marked C at the bottom of Figure 38. This is known as the Dumbbell Nebula.

Take careful note that the center of gravity which is in the drawing marked F is but a point, but where the centers are extended, as shown by the "x" in drawings A and B, the hole areas become bigger and bigger which makes the Dumbbell Nebula possible and contributes to the final great ring like the one marked D which is known as the Lyra Nebula.

The heavens are full of such dying suns. It is hard to realize that your own sun will die in this manner but it eventually will do so. New suns are continually being born, however, for our eternal Creator never stops thinking and the universe never stops recording God's thinking by its interchangings of pairs of opposites which constitute thought-waves.

The more you know the wave, therefore, the better you can command it to do your bidding. If you could visualize it objectively, it would look like a spherical diaphragm in a cosmic camera which would turn inside-out and outside-in for each wave.

This accounts for two things which science should know. One of them is that densities first increase from the inside toward the outside as holes in rings of light close up to become true spheres. The moment they become true spheres, densities then increase inward toward their centers. The other fact as yet unknown to Science is that as waves turn outside-in to create spheres, the color spectrum turns with them. The blue centers the rings and the red is on the rims. When true spheres have been formed, the red is on the inside and the blue on the outside.

Excellent color photos of the Lyra ring have proven this fact. The great hole is sky blue while the outside rim pictures the red end.

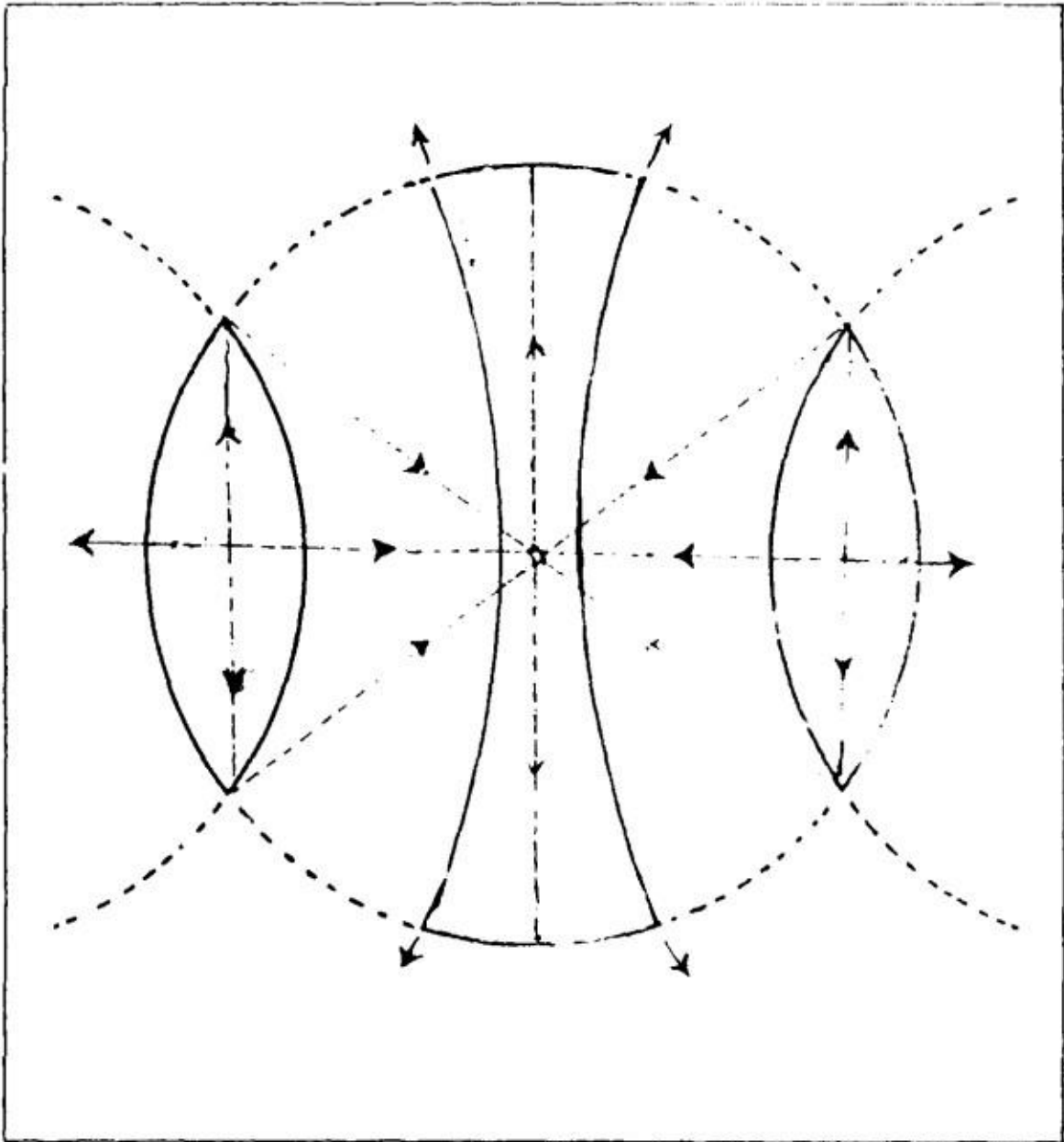

FIG. 37

God uses but two tools to create His curved universe of motion. With these, He creates the centripetal spirals which compress cold into heat and the centrifugal spirals which expand back into cold space. With the cube planes of zero curvature which comprise space, they mirror themselves into and out of each other. The mirrors of the cube universe of non-motion and the lenses of light of motion constitute our entire universe.

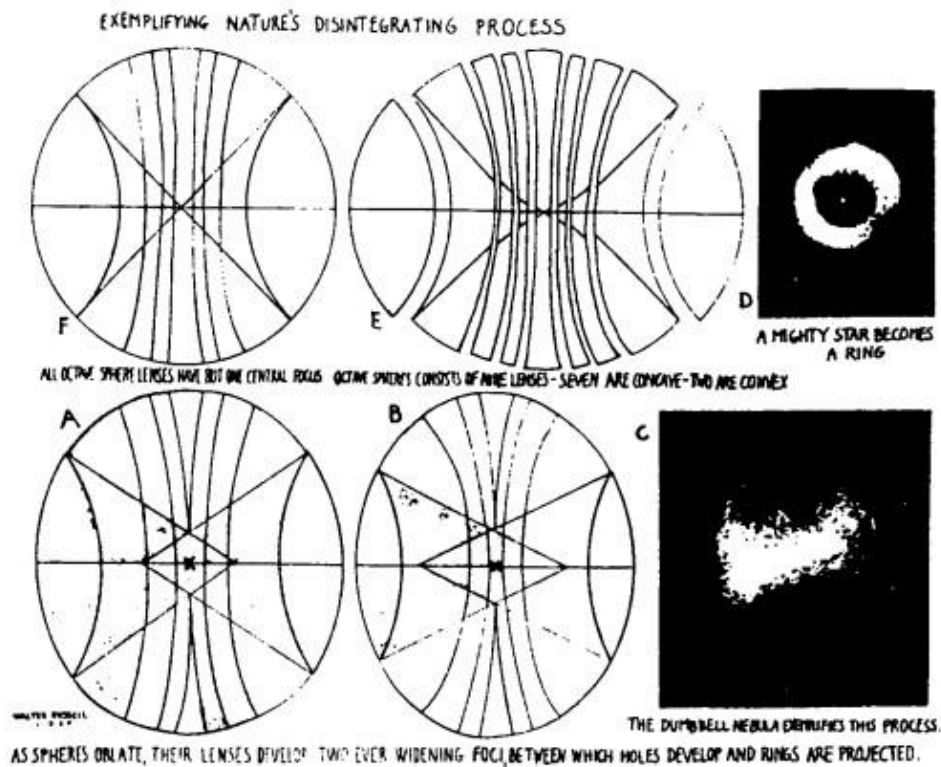

FIG. 38

This diagram fully details the manner in which the nine lenses of its construction bring generating light to a focus for redistribution as radiating light, as manifested by compression and expansion sequences. It also substantiates the uphill and downhill flow of energy which continues our universe of motion by its perpetual repetition of cycles.

This basic principle is true in all Nature, for the one thing that gives continuity is GROWTH. Nature GROWS, and there are no exceptions in her processes. Every tree in the forest and every flower in the garden is tubular until it fills its holes. The oak, mahogany and ebony are a few examples. This even applies to growing animal bodies. Every bone is tubular until it needs strength at the joints. Its marrow extends strength outward from its center to give that strength. The arteries also are tubular until they reach a state of solidity in the heart as bones do in the joints. The blood within them extends its strength outward to them in its endeavor to escape. Likewise, the air tubes, lungs, food-intake tubes and bowels press outward from within to give back to the earth for repetition of that which has been given to them for the same purpose.

Here, also, is irrefutable evidence to prove that atoms have no such nuclei as nuclear physicists believe. The textbooks and science articles picture all atoms as true spheres even to their electrons. Nature's processes do not work that way. When they do become true spheres, their centers do not act like the "glue" which holds them together; they thrust outward with increased resistance to their compressed condition.

In closing this discussion of the place which lenses fulfill in the creative process, we print two more diagrams. Figure 39 forcefully demonstrates the tremendous fires of

the sun as they shoot out at ninety degrees from the sphere's axis of rotation on line with its equator, while Figure 40 shows the gravity field which is created by that thrust and the direction of both thrusts of compression and expansion.

Let us begin a new chapter, please.

I AM --- GERMAIN

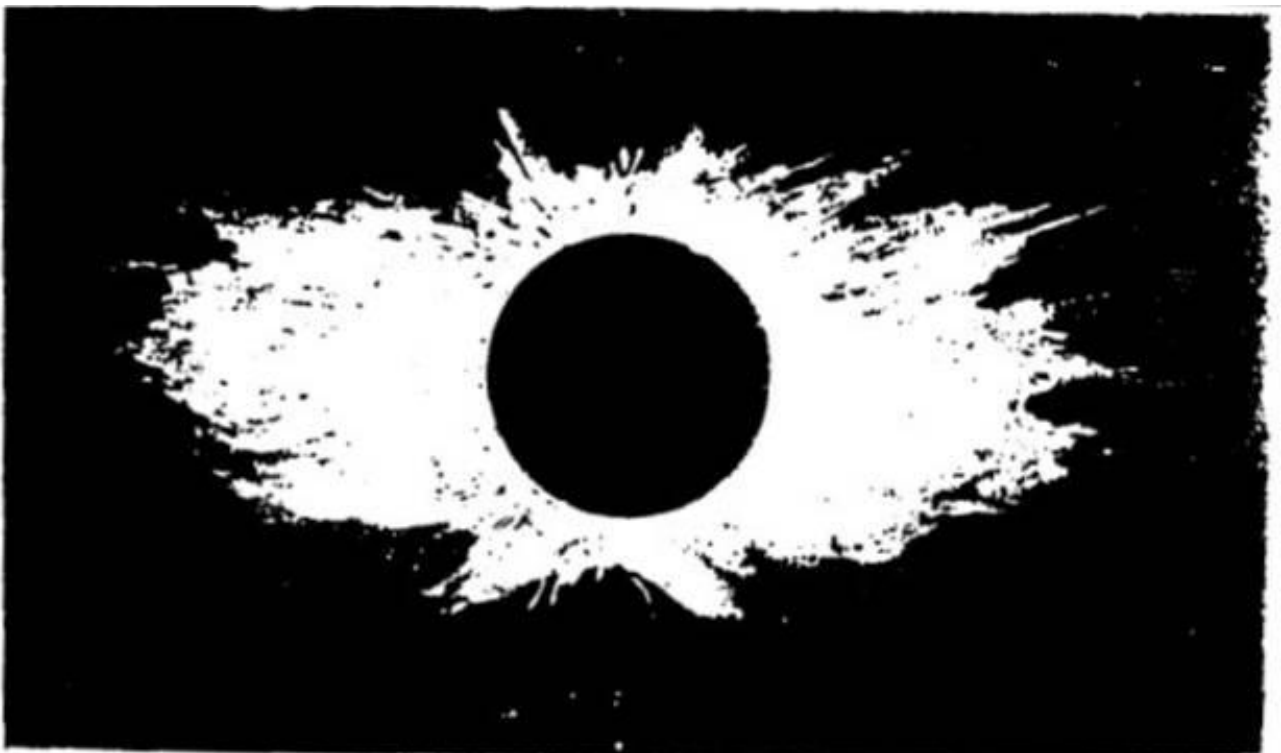
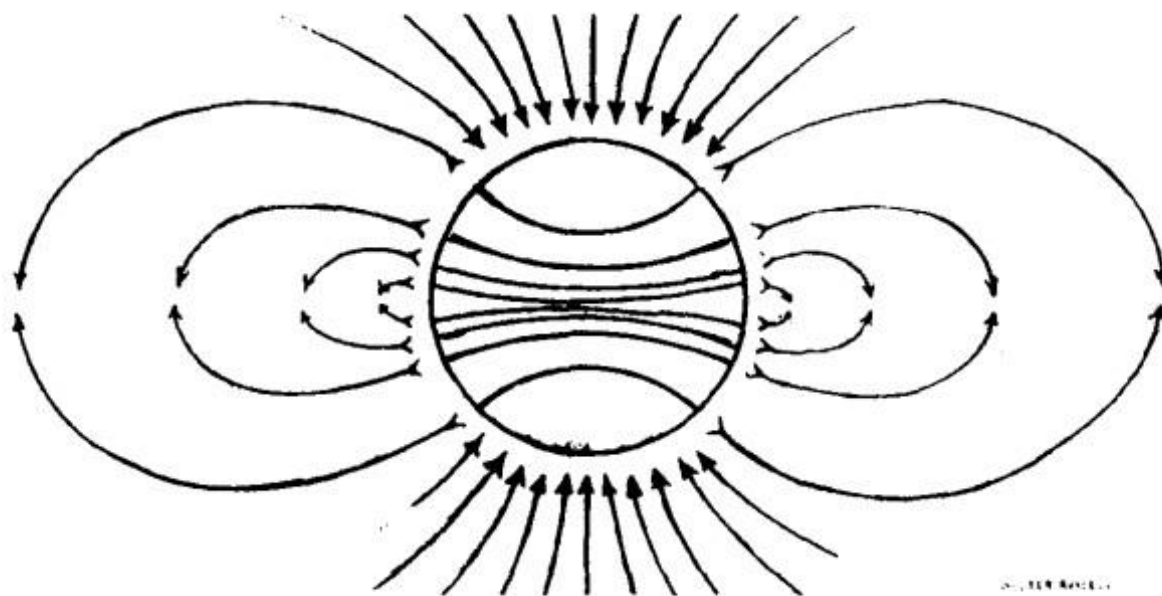

FIG. 39

This diagram gives emphasis to the tremendous thrust of radiation given forth from the sun to create its gravity field.



NATURE'S SEX PRINCIPLE

FIG. 40

This diagram again pictures the nine lenses of the sun which make of this curved universe a multiplier and divider of light. Its white center represents the Father-Mother ONENESS of the static universe of invisible light, while the divided spectrum manifests the pairs of opposite sexes which seek that oneness by again uniting for the purpose of again creating fathers and mothers. Through this division of light into pulsating light-waves, the sex principle is brought into being and eternal life is simulated by repetition of divisions.

CHAPTER 4

REC #3 GERMAIN

THURSDAY, AUGUST 29, 1991 2:43 P.M. YEAR 5, DAY 013

NATURE OF LIGHT

It is the nature of light to perpetually give of itself to every other light in all the universe, visible or invisible. This is why you "of the Light" are described in that manner--for you are as God--GIVING. The darkness (or "evil") "ONLY TAKES". That which is forever "taking" cannot merge with the universe which is made up of only Light. Therefore, you find that evil is, by necessity, a "thing" of only the physical expression for it is derived from the physical consciousness (ego) of the physical human species. That is why, further, evil is only present IN THE HUMAN SPECIES.

It is also the nature of all light, visible or invisible, to **REGIVE** that light to every other light in all this universe. Light does not TAKE other light; nor does anything in NATURE TAKE. TAKING IS NOT KNOWN IN NATURE'S PROCESSES.

All bodies in Nature are composed of light, whether they are incandescent like suns or cool like planets and all growing things upon them. Light given to these bodies continues their visibility by divided light-waves pulsing within them. While they are able to sustain their pulsing motion, it is said that they LIVE. When they are no longer able to continue their pulsing, it is said that they DIE .

Living is expressing that light which has been given. Dying is but regiving back to the ONE SOURCE that which has been given. All light comes **from** that one Source and is regiven **to** that one Source. That one Source is the CREATOR, the THINKER and KNOWER of the universe, the Father-Mother of the universe--omnipresent, omnipotent and omniscient. That is clearly descriptive of our Creator, for omnipresent means everywhere, omnipotent means the Father-Mother who has all-power, and omniscient means all-knowledge. We can no longer bring ourselves to use the word "HE" for our Creator, for nothing has been created other than by fathers and mothers, mineral, vegetable and animal. They, in turn, are creators of fathers and mothers. We use the term "He" simply because in your language expression it refers to a "being"--not sex, in sexual context.

God, therefore, extends power to all things to create all things by that process which we call growth.

The totality of the meaning of knowledge is IDEA. God has but ONE IDEA and that Idea IS CREATION. God divides His Idea into many ideas and gives them form by the thinking process. Man is but one idea and man also divides his idea into many

ideas and gives them form by man's thinking process. The Knower thinks LOVE and gives only love to all creatures of God's creations. Man's supreme desire is to love and to be loved, but in this present state of his knowledge he often creates fear and evil, and this fear and evil will destroy him until he realizes that love is all there is.

All created things have sufficient knowledge or instinct for their survival as idea. Animals can reason to some extent. Instinct fulfills the balance of their necessities. Vegetable life has its own way of protecting its body from being destroyed by its ability to grow. Although it has no means of protecting itself from destruction by defending itself as animals do with their claws and teeth, and as man does with his armaments, it knows how to become strong by resisting winds and refolding itself in winter weather to again unfold by the warmth of God's light. Mineral life has no such protection but to freeze itself in the light which created it and again melt through the heat of that very same light.

It will surprise the deepest thinker and knower among men to be told that God creates only two things, WATER AND FIRE. Just as two curvatures have been created as the only tools for creating the universe so, also, have only these two substances been created. Cold wetness and hot dryness constitute the bodies of all created substances we call "matter". Cold wetness surrounds our suns and prevents them from disappearing by the heat of their own fires even though millions of miles of cold space are needed to stop them from self-destruction. "Magnetic" storms sometimes cause the great fires which leap a hundred thousand miles or more into the cold wetness. In addition, the tremendous outward thrust of the solar corona itself increases the intensity of the sun's rays for millions of miles out into space, thereby affecting your earth's temperature and weather even though you are ninety million miles away from the sun.

Many times, huge suns conquer that cold wetness for a period and break away from their spherical forms by shooting great fires far out into space in almost successful attempts to escape. These near-to-exploding suns are known as novas, of which we see many in the heavens. The Crab nova is a conspicuous one. We herewith print a familiar picture of it. See Fig. 41. Also see Figs. 42 and 43.

The astronauts, John Glenn and Scott Carpenter, made an important notation while far out into cold space (at least this is the way the story goes). Glenn said he saw specks of light in front of his window. **This proved that there was sufficient atmosphere way out in space for the compression of his fast moving capsule to heat to incandescence even though its temperature for such low potential need not be high. This portion of the story is absolutely true.**

Carpenter also saw these particles even at a lower potential, but enough to give them body form. He reported that those he saw were SNOW. That report substantiates pretty well, our statement that one of the two things which God created is WATER. We need not prove that the other is FIRE, for FIRE is the CONSUMER of ALL THINGS.

We will return, now, to our discussion on the nature of light. Science makes one grave error in its conception as to what light DOES. Its textbooks on optics refer constantly to **PARALLEL RAYS** and picture them in their diagrams. The fact is that **there are NO parallel rays of light.**

This should be beginning to ring a lot of bells within the heads of photographers and motion picture "inventors and innovators" as to photographic projection, photographic equipment and right through to the technology of actually photographing THOUGHT PATTERNS in holographic form as readily as any other object. GOD WILL WORK WITH YOU, HE WILL NOT DO IT FOR YOU!

Even you, who are totally layman students, can prove it while sitting in your room at night with many lights turned on. You can readily see that every light spreads out its rays in conical forms which bend toward a plane of zero curvature. It then bends in converging conical rays toward its neighbor. Imagine the complexity of curvature as each light gives to the other. Imagine, also, what would happen to you who are sitting within the area of those many lights. If the rays were parallel, not one of those rays would lose its strength and their combined heat would burn you to a crisp. The heat from the sun would likewise burn the planets to a crisp, but you know that is impossible for its light **MUST** spread out through concavity from its center and grow weaker in intensity from that very center. If that is true of just one sun, imagine what the effect would be if all the stars of the heavens acted upon each other as the lights in your room would act upon you?

ARE YOU LISTENING, WALLY?

We will now fully explain the reasons why every focal point sends its rays outward from its center radially, from its focus, as shown on the concave lens in upper drawing (see Fig. 44) and in both convex and concave lenses in the lower drawings which have eliminated the parallel rays to create "magnetic" fields.

As every physicist knows, a wave is a hollow sphere of light surrounding a zero cold emptiness. In other words, **it is all hole.** The supreme effort of nature is to **fill that hole and produce solid spheres of intense heat . The reverse process then takes place by oblatting the spheres and allowing holes to again grow until they have dissipated all of the heat to become as fully empty as they were in the beginning.**

That is what waves are for. They divide the undivided, static cold into a hot dynamic universe of motion, a three-dimensional universe from a non-dimensional one. This they do by developing a compression force which shortens long, cold invisible rays into short visible rays. Waves also create an expansion force which unwinds the hot solid spheres into cold empty ones. Nature winds them centripetally and conically, and unwinds them centrifugally in one equatorial plane which is at an angle of ninety degrees from their conical axes.

Know that within these sentences is the answer as to WHY things show up on film (pictures) which were not "seen" with the eye. The "thing" or substance was there and in the reflection or response of the "light" made it visible to the substance on the film through the lenses. Ponder this a while--you don't need to ask me--or Hatonn-- about it, you will be given the answer as to HOW as you work through it. I ask this latter point because it is for you to know--not Dharma--and we cannot ask more of her in long explanations between us unless absolutely necessary for we have dozens of equally important messages which MUST be gotten through just as this one. Be confident in your mission--you ones would not be chosen if you had not the ability to conclude your purpose. So be it.

We print three diagrams to make the spiral principle more comprehensible. Figure 45 represents the vibrations of a harp string which multiply stillness into fast motion and produce audible tones corresponding to the octave principle of light waves. This drawing shows the spiral as though you were looking into the winding and unwinding of it, whereas that winding process takes place sideways from your point of view. You see it edgewise as we have indicated in the little drawing at the top. To make it even clearer to you, take a watchspring in your hand and look at it edgewise, then turn its face to you and you will see it as an architect does in making his plan and elevation on the same paper.

You ones here who mail packets to Wally may please "fax" this portion of the writing **(along with the pertinent diagrams)**. I want all information removed from the pages with the diagrams made available for your use--I DO NOT WANT CONFUSION OF ANY APPENDED VERBIAGE--IT WOULD ONLY CAUSE GREAT CONFUSION. Dharma, you understand what I am asking so please just trim the paper suitably. He needs the information as quickly as possible. Thank you.

In the lower left-hand corner, you will note the comparison between the **SOUND of the harp string and the LIGHT** of the spiral windings and unwindings of compressing and expanding light. The windings cause that phenomenon which we call **fusion**. The unwindings cause the effect of **fission**.

Figures 46 and 47 show the same principle as the harp string's winding and unwinding processes. Also the same spiral principle applies to its arrows. One points inward from without to compress or charge it centripetally with more power and the other points outward from within to dissipate that power by radiation.

As a layman student, it would be helpful to you if we give you a homely and familiar example of Nature's spiral winding and unwinding, conically and centripetally in many extending planes, and centrifugally in one equatorial plane which spins at an angle of ninety degrees from the axes of centripetal windings. The scientist will understand this without additional explanation.

You are all familiar with the cotton fibre which looms spin into yarns and cloth, string, ropes and other necessities for human existence. Why do men need to do this? Why

does Nature want to spin weak, invisible light rays into strong substances just as man spins weak and almost invisible cotton and linen fibres into strong, visible fibres like thin and thick ropes or strong cloths?



FIG. 41

The Crab Nebula. The most recent example of an exploding nova and the most distant one.

NEBULA FORMING
IN ORION,



FIG. 42

This nova in Orion is expanding to a heat death of zero cold by the usual process of spiral "pinwheels" caused by resistance to motion. This nova differs from the Crab nova, formerly a super-giant sun, by exploding into two parts, the smaller part becoming another giant sun.

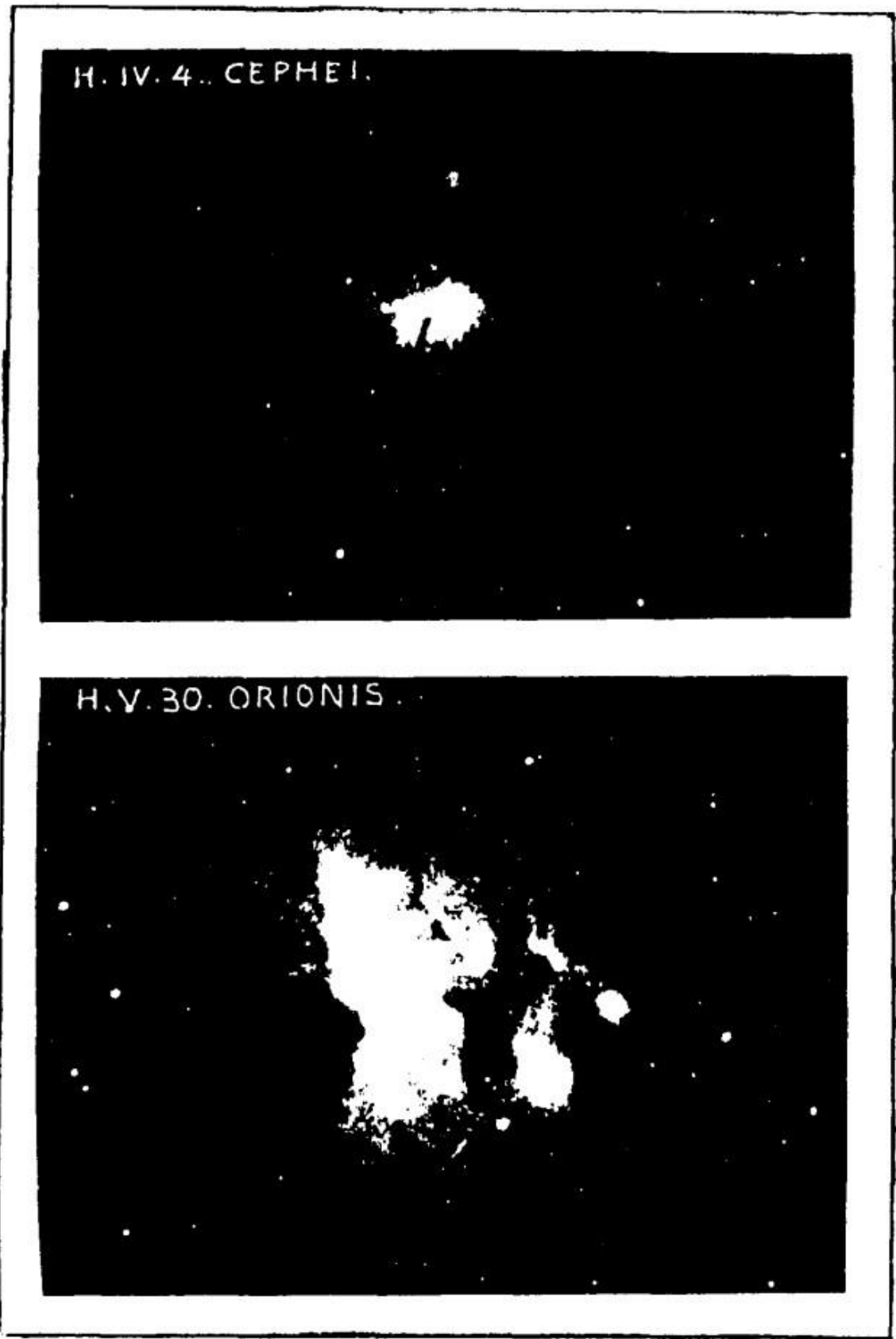

FIG. 43 Two exploding nebulas in Orion and Cephei which will send out fiery arms to form new star systems like the sun-spotted spiral pinwheels which are familiar objects in astronomical textbooks.

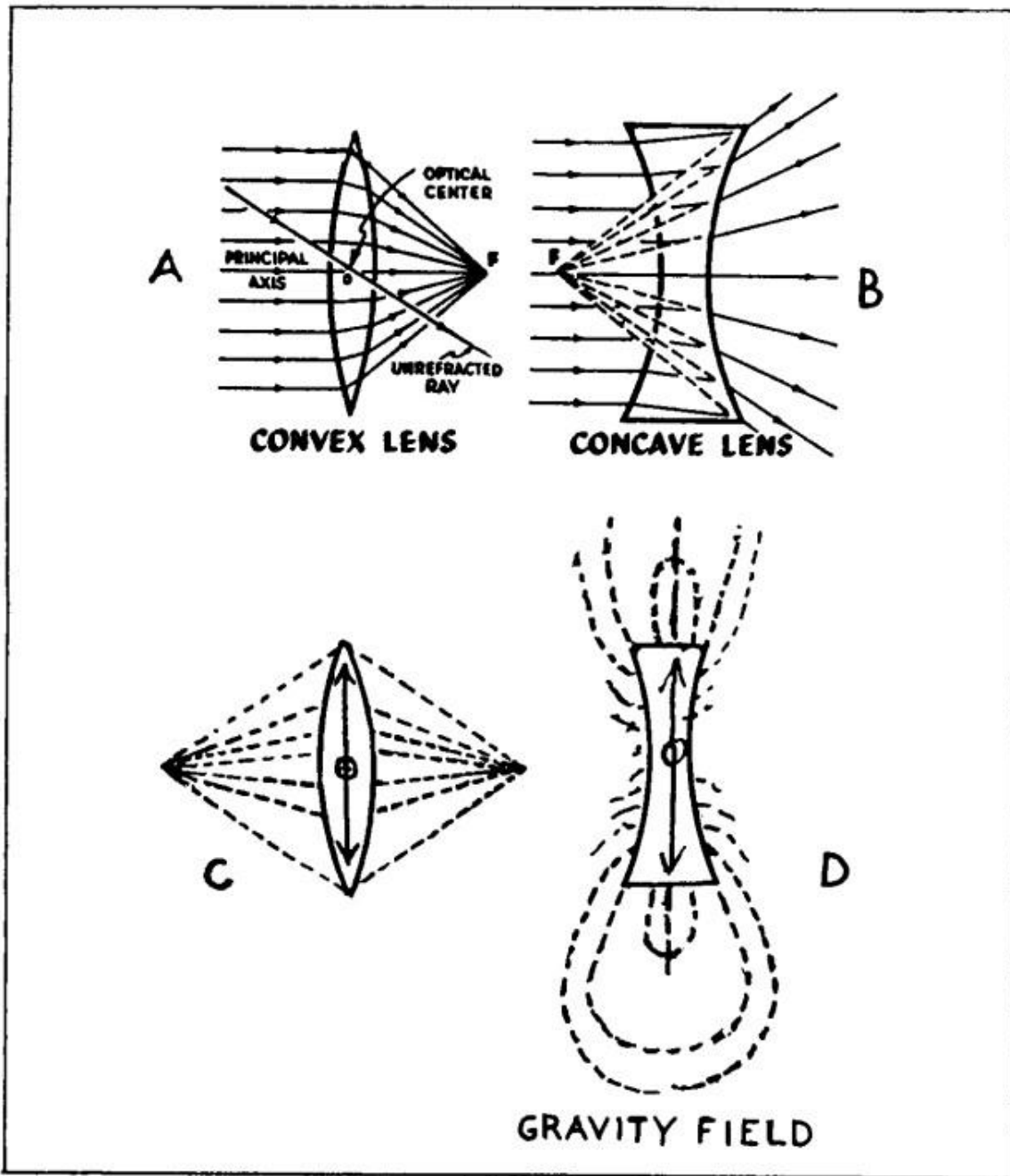

FIG. 44

"A" shows how the optical textbooks show parallel light rays striking a convex surface. "B" shows parallel light rays striking a concave surface. Lower diagram "C" shows how converging rays strike both surfaces and turn outward to create magnetic fields as shown in lower righthand drawing marked "D".

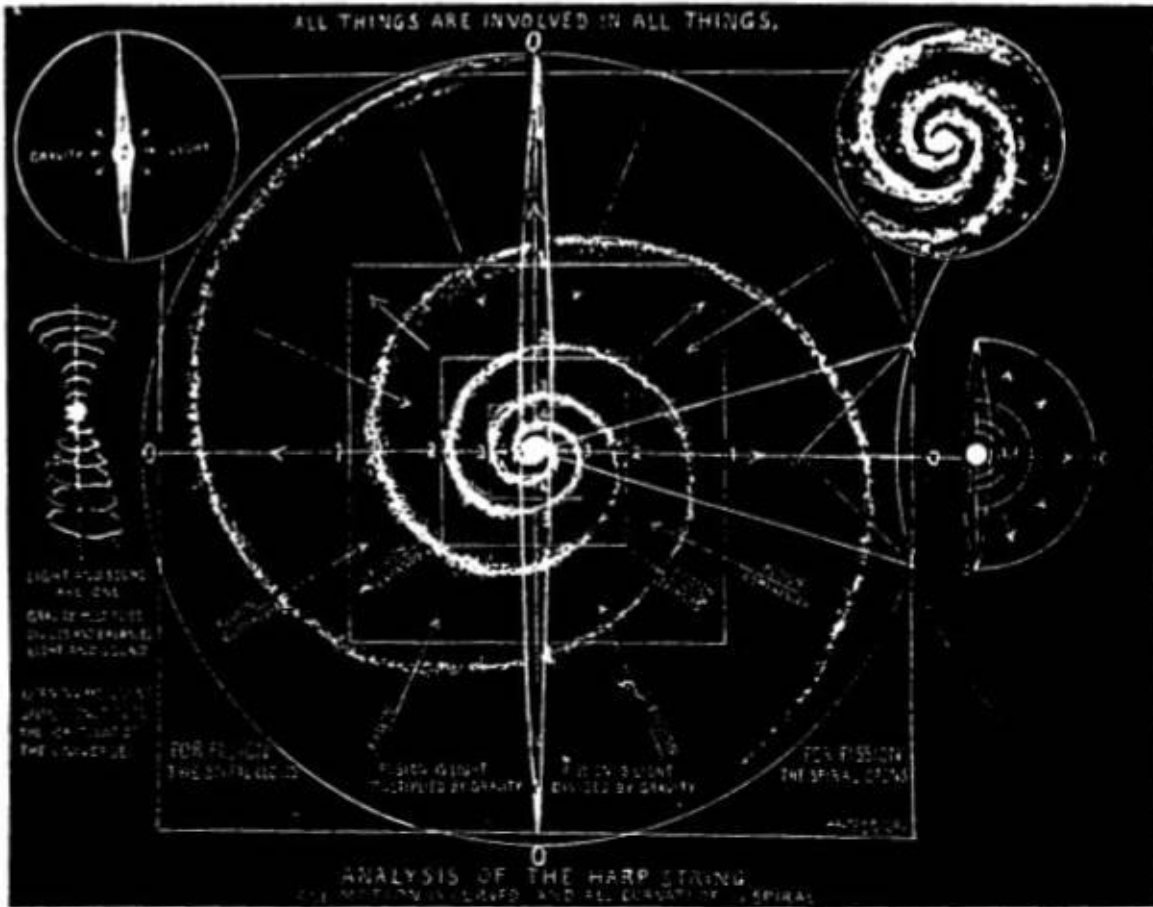

FIG. 45 Carefully study text for detailed explanation.



FIG. 46
Illustrating spiral principle in the winding
and unwinding processes of Nature.

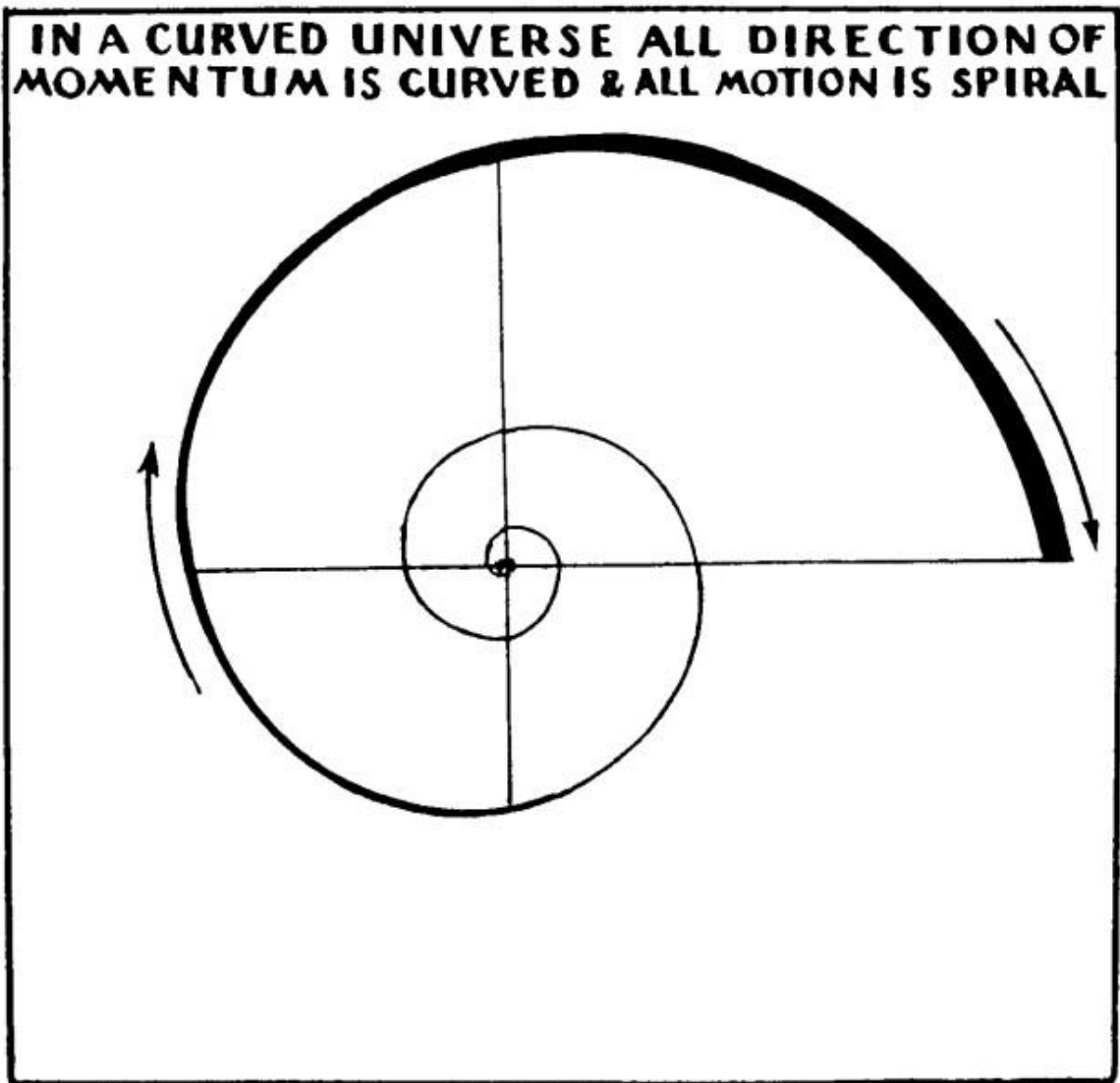

FIG. 47
Illustrating spiral principle in the starry heavens.

Nature does it to manifest her many ideas which have been divided from her one Idea of Creation. Man does it in order to manifest one of his many ideas by being able to survive the changing weather and to perform work which, also, characterizes the idea he manifests.

If you watch the workings of a loom which spins cotton into its various forms, you will notice that there are many threads which spin conically and centripetally into one thread or one piece of cloth. The more colors that are needed for the design of the cloth, the more complex the threads become. The same thing applies to the mother at home who knits yarns into thicker cords and cloths. She gathers them conically and in centripetal spirals and spins them into one stronger cord or cloth.

The more the physicist can command this principle of the windings and unwindings of Nature to produce visible light rays from invisible light rays, the more he can command and control gravity to perform his needed miracles. He has already learned to control it to a surprising extent as we have already outlined--in spite of having almost all WRONG information.

There are three great "miracles" possible for man's usage in the world today:

1. Power projection from anywhere to wherever one wishes to project it without the need of wires or cables. Tesla already had that scientifically perfected.
2. The power of converting solar rays to light and power. Tesla also had that well under development. J.P. Morgan, himself, buried these things from your use--good old Bankster that he was!
3. The power of transmuting one element of matter to another. Now, you KNOW that you CAN do this for all you have to do is look at plain old table salt. It is just a matter of understanding physics as properly given.

These three miracles of man's Mind-knowing will be discussed and their principles made crystal clear in another lesson (actually, we have already presented it to you prior to this but we shall repeat portions as a reminder).

We will sort of end our brief textbook for the new science built upon a new conception of the workings of Nature and will give clear directions for technically empowered men to make them possible--again.

The end result we desire to obtain is to make man see that the road map we are giving him leads to the very door of the creative Source. He will then thoroughly know that the power of the eternal God is the only possible answer not only to the Source of himself but to the Source of all Creation.

If we succeed in doing this, the atheism of part of the world will disappear, for no great nation will permit itself to fall behind the science standards of the God-believing free nations--IF YOU MAKE YOURS FREE, THAT IS. It will end the disunity of the great religions which have brought fear into the world by preaching sin and evil and punishment during life and after death through their conception of a god of wrath and vengeance. It will also bring balance into the world home and the family home. As a final achievement of colossal importance, it will end the degradation of woman and place her as an equal by man's side--IN PROPER PERSPECTIVE. These things having been achieved, the age of slaughter of such aeons-long experiencing will end and there will be brought into being the Age of Character based on love and the Oneness of all mankind--and that would be a worthy "New World Order". YOU CAN DO IT IF YOU WANT TO!

SUMMARY

What you have been given in this series of lessons--and will be given in the next--could be enlarged into many volumes for more detailed clarification. However, these lessons bring to you new knowledge which, if properly utilized, will bring to mankind a surcease of his hard labors for sustenance of his body and a wealth from natural resources as yet unknown to man.

We trust that the time has come in man's unfolding when he is ready to take this and use his earth's great natural supplies for the benefit and GOOD of all mankind. This can only be accomplished if man has a way of life in which he lives the inviolate law of RHYTHMIC BALANCED INTERCHANGE in all of his transactions, whether they be marital, social or business--and YES, YOU CAN EXPECT **TO FIND GOD IN EACH AND EVERY ONE OF THOSE THINGS--RIGHT ALONG SIDE SELF!** Wheresoever you go--I go, He has told you! We continue to remind you of that fact--are you always proud of where you take God and proud to see Him witness and participate in all of your activities? When you are like the child who says, "Dad--watch ME!--look at Me--See me!"--well, I think you get my drift - - -!

All of the glorious benefits of man's universe are of little avail if man does not live God's great Law of Balance. Until he does, he will have one tragic experience after another in his personal life which would ultimately multiply into worldwide catastrophes.

You must know that "To know the WAVE is to know the SECRET OF CREATION". To make YOU know the wave principle is the purpose of these lessons. For centuries, man has repeated the statement, "GOD IS LIGHT", and many there are who have thought of this God Light as the incandescent light which they can SEE. That God has given the new knowledge of the universe to man at this crucial period in his unfolding must indicate to you that man is now READY for it. Thus is man given the "tools" for his use. The world needs new fuels, water and metals for sustenance of an ever-increasing population and they must be produced at nominal cost to be within the reach of all. Then, the governments must be disallowed to consume them and keep them from the populace. You have a mighty but wondrous task at hand.

The key to obtaining these necessary items is being herein given within the Pleiadian documents so that you can have them in order to bring abundance and total change upon your expiring world. I ask God to help you see and hear your call to Serve! We give this knowledge now to meet the world's needs, with the deep desire and prayer that not only all man's needs will be met but that by so doing a new era may come into being wherein all mankind will become aware of its oneness with each other through a greater understanding of the principle of life itself--for to know this principle is to know HOW each man is dependent on his fellow man for happiness and survival since all living matter in this universe is a dynamic extension of itself. Working in unity, man will not only survive but he will live abundantly and ecstatically for he will then have become aware of WHO HE IS and WHAT HE IS and he will know his True purpose on Earth by expressing the great Laws of the Creator from Whom he extends.

With my warmest and most loving expression I ask that you study these writings and stay with us as we move on into the revealing of some of the secrets of the universe to you and give you a more complete picture of the ways and processes of God's glorious and inviolate Laws.

It is a joy beyond expression that I share in your receiving of these words with the gladness which is reflected back unto me and my brothers of these dimensions. Blessings unto you, my brothers and beloved co-workers. The journey has been long and fraught with obstacles and challenges, but with pun intended--I do believe we are beginning "to see the light at the end of the tunnel". Blessed be ye who wait upon God for in so doing, comes the wondrous perfection of the sequences.

I AM --- GERMAIN
MITAKUYE OYASIN
(for all my relations)

CHAPTER 5

REC #1 HATONN

FRIDAY, AUGUST 30, 1991 7:48 A.M. YEAR 5, DAY 014

FRIDAY, AUGUST 30, 1991

COMMUNISM FALL?

Dear ones, hold up--Hatonn here to point out some most uncomfortable truths.

I remind you that in the Soviet Union NOTHING is as it is being given to you. Worse--Communism is NOT. Russia, nor the Soviet Union, have EVER HAD COMMUNISM. To dissolve the Communist Party means NOTHING except that the Soviets have moved into a totally DEMOCRATIC DICTATORSHIP! Moreover, the one who expected to be Dictator--is not. Democracy can only work when there are honorable "choices". A "vote" means less than nothing if there is only one thing to vote for! Further, the "show" of the Soviet nations pulling away is exactly that--a show. It is simply a phase, now, of "divide and conquer". Again, I remind you to LISTEN. What is Cheney telling you about defense budgets? For one thing--the Russians still spend a massive amount on weapons and show no signs of lessening that amount--but rather, fully intend to up it as soon as the outside (from you) aid begins to flow. If YOU continue to fool yourselves, you are in serious trouble. Why do you think the Prime Minister of Great Britain is visiting the vacation home of Bush? Worse, the Queen didn't even bother to come herself.

A little secret--the Elite all have to stay on the better side of Great Britain for the holes for safety are in New Zealand and Australia. The full intent is that the Northern Hemisphere will be radioactive-- one way or another. Please attach the "Radiation Hazard USA" sheet and the "Fallout Patterns" to this document. (See Map 1 & 2)

Now for truth in presentation. A U.S. Supreme Court statement was made regarding the lying and manipulation compiled from proven findings and written up as a portion of the American Communications Association v. Douds, 339 U.S. 382,442. Let me quote:

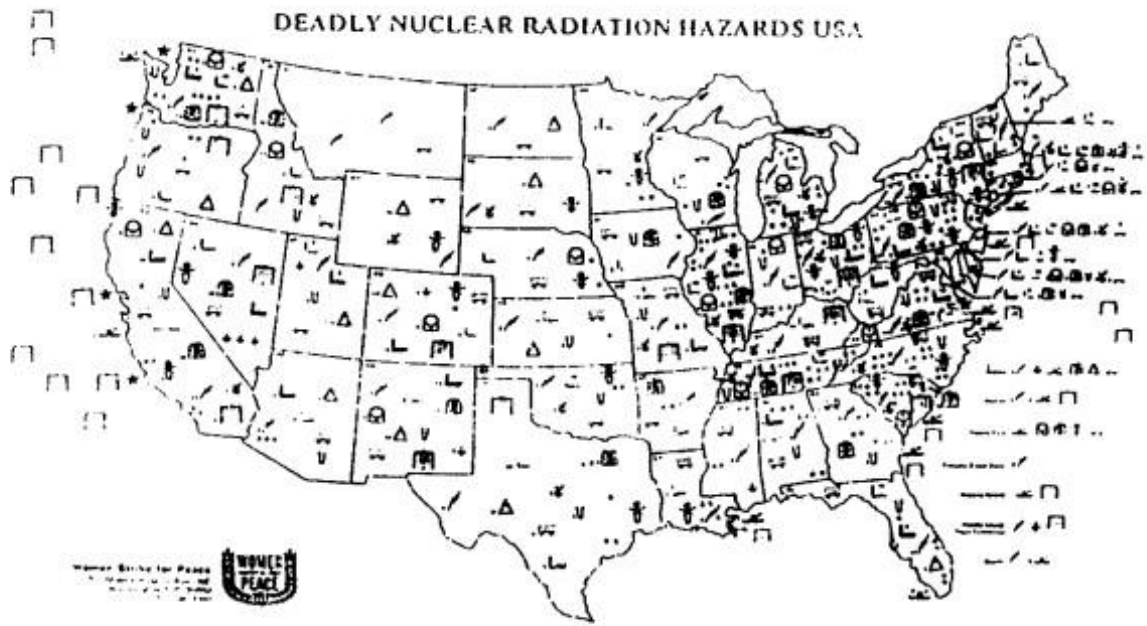

Manmade low level radiation is all about us and IS causing cancer, leukemia, cataracts, premature aging, damage to unborn children, genetic mutations for generations to come, fetal and infant deaths. High level radiation from weapons making, nuclear explosions and nuclear war can bring an end to all life on earth. Plutonium was named for Pluto, the lord of hell. At present over 90% of the volume of manmade radioactivity results from the weapons program. By the year 2000 the worldwide production of long-lived radioactivity will be equal to exploding about 3 million Hiroshima bombs per year. Dr. John Goffman: "It violates minimum morality for any generation of humans to produce a radioactive legacy which IRREVERSIBLY endangers the future of all generations to come."

End the arms race—not the human race.

L. Franklin - Ramirez. Permission to copy required if there are changes to statistics.

- | | |
|--|---|
| NUCLEAR WEAPONS
(Design, Testing, Production, Storage and Army & Air Force Deployment Bases) | NUCLEAR POWER PLANTS
Accounting for 98% High-Level Accumulation
Radioactive Waste (including Spent Fuel) |
| NUCLEAR-CAPABLE SHIP AND SUB BASES | OPERABLE |
| NUCLEAR TEST EXPLOSIONS | INOPERABLE/SHUTDOWN |
| NUCLEAR INDUSTRIES (Military, Naval) | UNDER CONSTRUCTION |
| NUCLEAR INDUSTRIES (Commercial) | PLANNED |
| MILITARY AND D.O.E. RESEARCH REACTORS (Operable) | UNIVERSITY RESEARCH REACTORS (Operable) |
| MILITARY AND D.O.E. RESEARCH REACTORS (Inoperable) Accounting for 98% High-Level Accumulation Radioactive Waste | UNIVERSITY RESEARCH REACTORS (Inoperable) |
| RADIOACTIVE MATERIALS (Transportation, Packaging, Uncontaminated, Contaminated, Storage) | URANIUM MINES, MILLS, TAILINGS |
| | PROCESSING FACILITIES (Plutonium & Uranium) |
| | PORTS OF ENTRY—Uranium Ore and Spent Fuel |
| | RADIOACTIVE WASTE BURIAL GROUNDS (On Land and Off Shore) (Land and Sea Burial) |

Original Research from U.S. Government Sources:
 Department of Defense (DOD); Department of Energy (DOE); Nuclear Regulatory Commission (NRC); Bureau of Mines. Information also drawn from: State by State Guide to Nuclear Facilities; Another Mother for Peace; the NARMIC Maps; American Friends Service Committee; "Nuclear America"; War Registers; "The Nuclear News Buyers Guide"; American Nuclear Society.
 Designed by James True and Carol Gerson, Graphic Artists.
 Researched and prepared by Louise Franklin-Ramirez, Virginia Women for Peace and Gray Panther.

you are already nuked! Major fallout will begin by next year from load already in space

(You are already nuked! Major fallout will begin by next year from load already in space. Gyeorgos C. Hatonn)

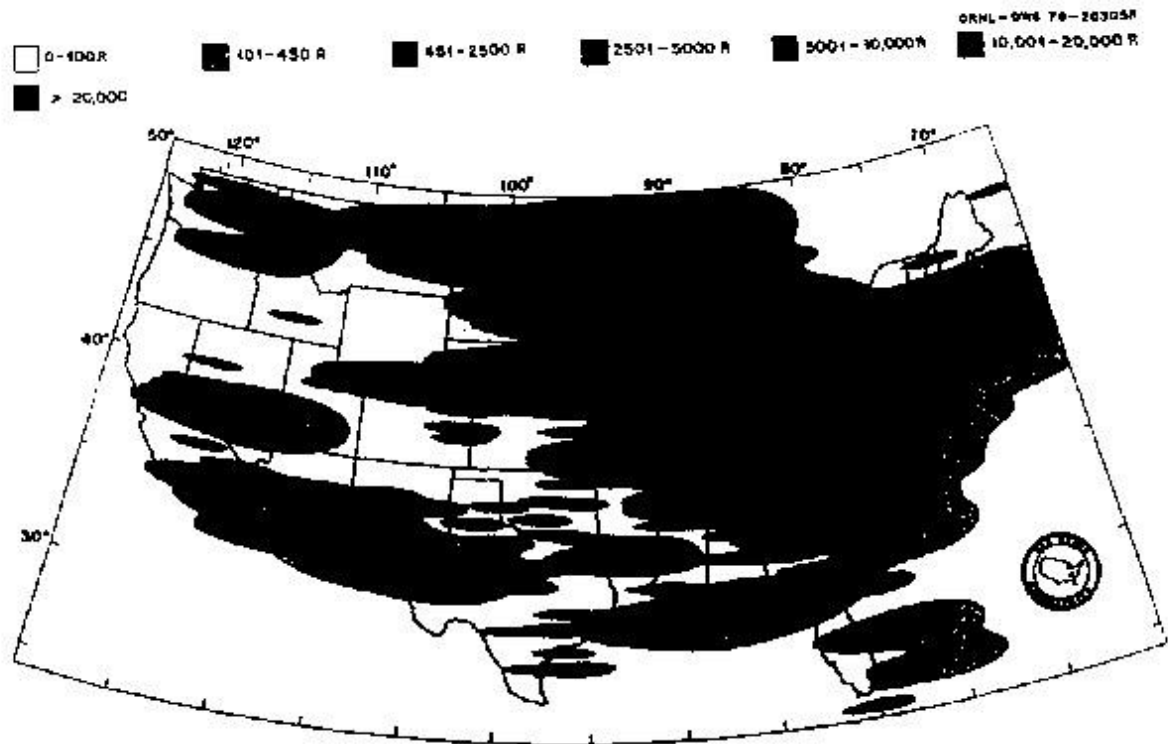

Fig. 4.1. Simplified fallout pattern showing total radiation doses that would be received by persons on the surface and in the open for the entire 14 days following the surface burning of 5050 megatons on the targets indicated, if the winds of all directions blew continuously from the west at 25 mph.

Text: (Fig. 4.1 Simplified fallout pattern showing total radiation doom that would be received by persons on the surface and in the open for the entire 14 days following the surface burning of 5050 megatons on the targets indicated if the winds of all directions blew continuously from the west at 25 mph.)?

In a 1986 New York Times-CBS News poll survey of 2,016 adults about incidents of the White House lying to the American public, only 1 percent of those surveyed thought that the administration told the truth all the time, 53 percent said the administration told the truth only some of the time, while 9 percent said it hardly EVER told the truth. Americans should question now whether the current administration under a former CIA Director's leadership can speak to us with more candor than the last administration under Ronald Reagan, a former Hollywood actor.

We live in a highly manipulated world. Ideas are manipulated through purposeful distortions in the press and selective omissions in our all-pervasive public education

(indoctrination) system. Economic and political realities are falsified by self-serving establishment controllers and their minions in the bureaucracy.

Our society is controlled by an "aristocracy", a small elite group of individuals who, through control of the government, have obtained special privileges in law and are thus able to live as parasites off the labor of others (mostly the hard-working American middle class) and amass large amounts of unearned wealth.

This current aristocracy operates covertly and by deceit. The bankers are the main (but not the only) element in this covert aristocracy. Using many of the standard principles of aristocracy (authoritarianism, statism, and the use of an intellectual priesthood to deceive the public) they have created a social system where robbery and exploitation are systematized and legalized and where resistance to the robber has been made a crime.

"It is not the function of our Government to keep the citizen from falling into error; it is the function of the citizen to keep the government from falling into error."--U.S. Supreme Court

NOW IS THE TIME!

OK, it is done. Col. James Gritz is now officially announced as running for the office of President of the United States of America. He is "announced" under the shelter of the Populist Party--which, like all organized political operations, has many and varied flaws. Do not let this deter you from your duty as an American to get this man elected to office so that the flaws can be eliminated. You need votes and support, you need unification, for there is no difference whatsoever in the Democratic and Republican parties. In fact, all will now be done to pull down a dictatorship on you-the-nation prior to the '92 election so that there will not be an election. It is up to you!

I am informed that America West will be offering backing and high visibility integration with the effort to elect Col. Gritz and I shall do everything allowed to see to it that he is elected for he is chosen of God for the task. I have quite a bit of "pull"--but if you-the-people do not support this in a massive manner--why would you expect God to DO IT FOR YOU? I guarantee that I have a very nice and totally workable relationship with this man--which is boggling the minds of the UFO conspirators. I suggest that if you have ones in the "Little Gray Alien" with Cooper conspiracy--that you alert them. There are heinous things planned by the disinformers to terrify America and parts of the world to finish pulling you into captivity--"against a common enemy". YOUR ENEMIES SIT IN THE LEADERSHIP OF YOUR NATIONS AND WITHIN THE BANKS--THERE ARE NO ENEMIES IN SPACE! WHAT YOU WILL BE GIVEN AS "PROOF" IS A WORSE LIE THAN ANY THEY HAVE CONJURED THUS FAR AND ONLY KNOWLEDGE OF TRUTH CAN KEEP YOU FROM FALLING FOR THE TRAP!

Let me say something to you as a people of world citizenship. You are in the sorting of God's people from the ones who wish to follow this evil empire. We are now dealing with God's adversary who is restricted to the mortal physical plane. The intent is to take the planet earth and then move outward into space. IT WILL NOT BE ALLOWED AND THERE WILL BE MASSIVE EFFORT TO HOLD THE BEINGS OF EARTH HOSTAGE. WELL, SORRY ABOUT THIS--EARTH-MAN; GOD DOES NOT COMPROMISE NOR DOES HE NEGOTIATE. YOU EACH WILL BE EITHER ON ONE SIDE OR THE OTHER AND TO NOT MAKE A DECISION IS TO ALREADY HAVE MADE ONE.

All manner of terrible things are in the planning by the deceivers to perpetrate upon you in the guise of it being Space Brothers. No, but you will buy the tale in great masses. However, if you-the-people of the United States of America fail to fall for the lie--you will prevail and the world shall be turned about for GOD WILL WORK WITH YOU IF YOUR INTENT IS TRUTH AND HONOR--HE WILL NOT DO IT FOR YOU. IF YOUR INTENT REMAINS TO CONTINUE THE BREAKING OF EVERY LAW OF GOD AND THE CREATION--YOU ARE RESPONSIBLE FOR THAT WHICH COMES UPON YOU AND IT SHALL COME UPON YOU IN A MOST DEVASTATING MANNER FOR WE WILL ONLY AIRLIFT OUT GOD'S PEOPLE. WE HAVE NO AUTHORITY TO REMOVE ANY WHO PRACTICE EVIL FOR THOSE ONES ARE NOT WELCOME IN THE BALANCED SOCIETIES OF THE COSMOS. SO BE IT.

If you turn around the government of the U.S.--the chosen people and place of God--you can reclaim your planet. What else do you have to do with even a tenth as much wondrous challenge and excitement? You are a bored and sleepy civilization--stop watching the play on your pretend screens and get into the game, dear friends. God has sent Us, His Hosts, to play with you--WE HAVE NO INTENTION OF COMPETING WITH YOU FOR OUR ENEMY IS THE ADVERSARY OF GOD AND WE NEED NOT A "THREE" RING CIRCUS. NO ONE SHALL BE COERCED OR FORCED--***YOU WILL BE IN THE CHOOSING.***

LAWYERS, YOU HAVE LAWYERS!

Oh my, yes you do! However, since you ones fail to know anything about your Constitution--I get to lay another heavy trip on you. How many Amendments do you have? Do you know that it is UNCONSTITUTIONAL FOR A LAWYER TO BE ELECTED TO CONGRESS? WHAT DOES YOUR THIRTEENTH AMENDMENT SAY? Well, NOW it reads: *"Neither slavery nor involuntary servitude, except as a punishment for crime whereof the party shall have been duly convicted, shall exist within the United States, or any place subject to their jurisdiction...etc."*

Ah, but not so. THAT WAS THE 14TH AMENDMENT I JUST CITED. THE ORIGINAL 13TH AMENDMENT READS AS FOLLOWS:

*"If any citizen of the United States shall accept, claim, receive, or retain any **TITLE OF NOBILITY or HONOUR**, or shall, without the consent of Congress, accept and retain any present, pension, office, or emolument of any kind whatever, from any emperor, king, prince, or foreign power, such person shall cease to be a citizen of the United States, and shall be incapable of holding any office of trust or profit under them, or either of them." (Emphasis added)*

Thank you, David Dodge, Researcher and Alfred Adask, Editor, *AntiShyster*, August, 1991:

These ones also give you a special version of the pledge of allegiance you might consider--for it says what the original MEANT and ceased to be accepted: *I pledge allegiance to the Constitution of the United States of America, and to the Republic **that honors that Constitution**, one nation, under God, with Liberty and Justice for all.*

MISSING 13TH AMENDMENT

"TITLES OF NOBILITY" AND "HONOR"

In the winter of 1983, archival research expert David Dodge, and former Baltimore police investigator Tom Dunn, were searching for evidence of government corruption in public records stored in the Belfast Library on the coast of Maine. By chance [?--I think not!], they discovered the library's oldest authentic copy of the Constitution of the United States (printed in 1825). Both men were stunned to see this document **included a 13th Amendment that no longer appears on current copies of the Constitution.** Moreover, after studying the Amendment's language and historical context, they realized the principle intent of this "missing" 13th Amendment **WAS TO PROHIBIT LAWYERS FROM SERVING IN GOVERNMENT....!**

So began a seven-year, nationwide search for the truth surrounding the most bizarre Constitutional puzzle in American history--the unlawful REMOVAL OF A RATIFIED Amendment from the Constitution of the United States. Since 1983, Dodge and Dunn have uncovered additional copies of the Constitution with the "missing" 13th Amendment **printed in at least eighteen separate publications by ten different states and territories over four decades from 1822 to 1860.**

In June of this year (1991), Dodge uncovered the evidence that this missing 13th Amendment **had indeed been LAWFULLY RATIFIED by the state of Virginia and was therefore an authentic Amendment to the American Constitution.** The evidence is correct and no errors are found--a 13th Amendment restricting lawyers from serving in government **was ratified in 1819 and REMOVED from your Constitution during the tumult of the Civil War--deliberately!**

Since the Amendment **was never LAWFULLY REPEALED, IT IS STILL THE LAW TODAY!** Wouldn't you now guess that the implications are ENORMOUS?

The story of this "missing" Amendment is complex and at times confusing because the political issues and vocabulary of the American Revolution were different from your own. However, there are essentially two issues: **What does the Amendment mean? and, Was the Amendment ratified?** Lets look first at the "meaning".

MEANING

The "missing" 13th Amendment to the Constitution of the United States reads as above cited.

At first reading, the meaning of this 13th Amendment (also called the "title of nobility" Amendment) seems a bit obscure, unimportant. The references to "nobility", "honour", "emperor", "king", and "prince" lead you to dismiss this amendment as a petty post-revolution act of spite directed against the British monarchy. But in your modern world of Lady Di and Prince Charles, anti-royalist sentiments seem so archaic and quaint that the Amendment can be ignored. NOT SO!

Consider some real hard evidence **of its historical significance:** First, "titles of nobility" were prohibited in both Article VI of the *Articles of Confederation (1777)* and in *Article I, Sect. 9 of the Constitution of the United States (1788)*; Second, although already prohibited by the Constitution, an additional "title of nobility" amendment was proposed in 1789, again in 1810, and was finally ratified in 1819. Clearly the founding fathers saw such a serious threat in "titles of nobility" and "honors" that anyone receiving them would **FORFEIT THEIR CITIZENSHIP.** (How about Sir Schwarzkopf? and Sir Dr. Kissinger?) Since the government prohibited "titles of nobility" several times over four decades, and went through the amending process (even though "titles of nobility" were already prohibited by the Constitution), it's obvious that the Amendment carried much more significance for your founding fathers than is readily apparent to you today.

HISTORICAL CONTEXT

To understand the meaning of this "missing" 13th Amendment, you must understand its historical context--the era surrounding the American Revolution (which of course, you are not taught).

You tend to regard the notion of "Democracy" as benign, harmless, and politically unremarkable. But at the time of the American Revolution, King George III and the other monarchies of Europe saw Democracy as an unnatural, ungodly ideological threat, every bit as dangerously radical as Communism. [So, the obvious solution was to turn Democracy and Communism into a method of creating what they wanted in the first place, a Monarchy-Dictatorship, while calling it nice labels]. Just as the 1917 Communist Revolution in Russia [financed by you nice people's bankers just as the so-

called Soviet Revolution this week is sponsored and financed by the same nice people in your behalf] spawned other revolutions around the world, the American Revolution provided an example and incentive for people all over the world to overthrow their European monarchies--or so it was interpreted.

Even though the Treaty of Paris ended the Revolutionary War in 1783, the simple fact of your existence threatened the monarchies. The United States stood as a heroic role model for other nations that inspired them to also struggle against oppressive monarchies. The French Revolution (1789-1799) and the Polish national uprising (1794) were in part encouraged by the American Revolution. Though you stood like a beacon of hope for most of the world, the monarchies regarded the United States as a political "typhoid Mary", the principle source of radical democracy that was destroying monarchies around the world.

The monarchies must have realized that if the principle source of that infection could be destroyed, the rest of the world might avoid the contagion and the monarchies would be saved.

Their survival at stake, the monarchies sought to destroy or subvert the American system of government. Knowing they couldn't destroy you militarily, they resorted to more covert methods of political subversion, employing spies and secret agents skilled in bribery and legal deception--it was, perhaps, the first "cold war". Since governments run on money, politicians run FOR money, and money is the usual enticement to commit treason, much of the monarchy's counter-revolutionary efforts emanated from English banks.

DON'T BANK ON IT

The essence of banking was once explained by Sir Josiah Stamp, a former president of the Bank of England. I have given this before but it is such a dandy, I shall repeat it: *"The modern banking system manufactures money out of nothing. The process is perhaps the most astounding piece of sleight of hand that was ever invented. Banking was conceived in inequity and born in sin... Bankers own the earth. Take it away from them but leave them the power to create money, and, with a flick of a pen, they will create enough money to buy it back again.... Take this great power away from them and all great fortunes like mine will disappear and they ought to disappear, for then this would be a better and happier world to live in.... But, if you want to continue to be the slaves of bankers and pay the cost of your own slavery, then let bankers continue to create money and control credit."*

One of the past great abuses of your banking system caused the depression of the 1930's. Today's abuses are causing another and more massive depression than the world has ever known. Current S&L and bank scandals illustrate the on-going relationships between banks, LAWYERS, politicians, and government agencies (look at the current BCCI and BNL scandals running from high government officers to the Presidency itself involved in totally criminal activities) such as the Federal Reserve,

the FDIC, and even the CIA. These scandals are the direct result of years of law-breaking by an alliance of bankers and lawyers using their influence and money to corrupt the political process and rob the public. (Think you're not being robbed? Guess who's going to pay the bill for the excesses of these bailouts?) As Oberli and Dharma track further and deeper into involved parties attached to this present property scam/scandal--they are finding other financial institutions involved and, as named in the investigation, find Salomon Brothers and other financial institutions who are kaput and haven't even been made public--no wonder the FDIC and RTC are asking additional BILLIONS.

The systematic robbery of productive individuals by parasitic bankers and lawyers is not a recent phenomenon. This abuse is a human tradition that predates the Bible and spread from Europe to America despite early colonial prohibitions. (Remember the Protocols of Zion? Try the issue of Oct. 1920: No. 13: "**We have already established our own men in all important positions. We must endeavor to provide the Goyim (non-Jews and including Judeans/Hebrews) with LAWYERS and doctors; the LAWYERS are au courant with all interest....**", and 14: "**But above all let us monopolize Education. By this means we *spread ideas that are useful to us, and shape the children's brains as suits us.***" And then, 15: "**If one of our people should unhappily fall into the hands of justice amongst the Christians, we must rush to help him; *find as many WITNESSES AS HE NEEDS TO SAVE HIM FROM HIS JUDGES--UNTIL WE BECOME JUDGES OURSELVES!***"

It is about time to again publish the Protocols, friends, but I have quite a bit of additional updating to do prior to that so let us hold up herein and not get sidetracked from the "missing" 13th Amendment--it is all tied in together, as you might have guessed by now. You may as well consider that there is total integration of the PROTOCOLS OF ZION, the CREMIEUX MANIFESTO, and the epistle emanating from the "PRINCE OF THE JEWS". Isn't it interesting that these were published in a Rothschild magazine? The "Prince of the Jews" was done in 1489 A.D. But then, who would ever think, most especially Gentiles, of connecting these things with other documents emanating from Jewry, or with modern happenings? So be it!

When the first United States Bank was chartered by Congress in 1790, there were only three state banks in existence. At one time, banks were prohibited by law in most states because many of the early settlers were all too familiar with the practices of the European goldsmith banks.

Goldsmith banks were safe-houses used to store client's gold. In exchange for the deposited gold, customers were issued notes (paper money) which were redeemable in gold. The goldsmith bankers quickly succumbed to the temptation to issue "extra" notes, (unbacked by gold). Why? Because the "extra" notes enriched the bankers by allowing them to buy property with notes for gold that they did not own, gold that did not even exist.

Colonists knew that bankers occasionally printed too much paper money, found themselves over-leveraged, and caused a "run on the bank". If the bankers lacked sufficient gold to meet the demand, the paper money became worthless and common citizens left holding the paper were ruined. Although over-leveraged bankers were sometime hung, the bankers continued printing extra money to increase their fortunes at the expense of the productive members of society. (The practice continues to this day and offers "sweetheart" loans to bank insiders, and even provides the foundation for deficit spending and your federal government's unbridled growth).

PAPER MONEY

If the colonists forgot the lessons of goldsmith bankers, the American Revolution refreshed their memories. To finance the war, Congress authorized the printing of continental bills of credit in an amount not to exceed \$200,000,000. The states issued another \$200,000,000 in paper notes. Ultimately, the value of the paper money fell so low that they were soon traded on speculation from 500 to 1000 paper bills for one coin.

It's then suggested that your Constitution's prohibition against a paper economy--"No State shall... make any Thing but gold and silver Coin a tender in Payment of Debts"--was a tool of the wealthy to be worked to the disadvantage of all others. But only in a "paper" economy can money reproduce itself and increase the claims of the wealthy at the expense of the productive.

"Paper money", said Pelatiah Webster, "polluted the equity of our laws, turned them into engines of oppression, corrupted the justice of our public administration, destroyed the fortunes of thousands who had confidence in it, enervated the trade, husbandry, and manufactures of our country, and went far to destroy the morality of our people."

CONSPIRACIES

Be patient--it may "seem" that I am not on the same subject but I am.

A few examples of the attempts by the monarchies and banks that almost succeeded in destroying the United States:

According to the *Tennessee Laws 1715-1820*, vol II, p.774, in the 1794 Jay Treaty, the United States agreed to pay 600,000 pounds sterling to King George III, as reparations for the American Revolution (interesting?). The Senate ratified the treaty **in secret session** and ordered that it not be published. When Benjamin Franklin's grandson published it anyway, the exposure and resulting public uproar so angered the Congress that it passed the Alien and Sedition Acts (1798) **SO FEDERAL JUDGES COULD PROSECUTE EDITORS AND PUBLISHERS FOR REPORTING THE TRUTH ABOUT THE GOVERNMENT.**

Since you had WON the Revolutionary War, why would your Senators agree to pay REPARATIONS to the loser? And why would they agree to pay 600,000 pounds sterling, eleven years AFTER the war ended? It just doesn't seem to make sense does it? Especially in light of the Senate's secrecy and later fury over being exposed, UNLESS YOU ASSUME YOUR SENATORS HAD BEEN BRIBED TO SERVE THE BRITISH MONARCHY AND BETRAY THE AMERICAN PEOPLE--THAT, DEAR ONES, IS SUBVERSION!

The United States Bank had been opposed by the Jeffersonians from the beginning, but the Federalists (the pro-monarchy party) won-out in its establishment. The initial capitalization was \$10,000,000--80% of which would be owned by foreign bankers. Since the bank was authorized to lend up to \$20,000,000 (double its paid in capital), it was a profitable deal for both the government and the bankers since they could lend, and collect interest (usury) on, \$10,000,000 THAT DID NOT EXIST.

However, the European bankers outfoxed the government and by 1796, the government owed the bank \$6,200,000 and was forced to sell its shares. (By 1802, your government OWNED NO STOCK IN THE UNITED STATES BANK.)

The sheer power of the banks and their ability to influence representative government by economic manipulation and outright bribery was exposed in 1811, when the people discovered that European banking interests OWNED 80% OF THE BANK. Congress, therefore, refused to renew the bank's charter. This led to the withdrawal of \$7,000,000 in specie by European investors, which in turn, precipitated an economic recession, and the War of 1812.

There are other examples of the monarchy's efforts to subvert or destroy the United States; some are common knowledge, others remain to be disclosed to the public. There is, for example, a book called 2 VA LAW in the Library of Congress Law Library. This is an uncatalogued book in the rare book section that reveals a plan to OVERTHROW THE CONSTITUTIONAL GOVERNMENT BY SECRET AGREEMENTS ENGINEERED BY THE **LAWYERS**. THAT, DEAR ONES, IS ONE REASON THAT THE 13TH AMENDMENT WAS RATIFIED BY VIRGINIA AND THE NOTIFICATION '**LOST IN THE MAIL**'. **THERE IS NO PUBLIC RECORD OF THIS BOOK'S EXISTENCE!**

Does this sound surprising? Perish the thought of "surprising". The Library of Congress has over 349.402 uncatalogued rare books and 13.9 MILLION UN-CATALOGUED RARE MANUSCRIPTS, LAWS AND RATIFICATIONS! ***THERE ARE SECRETS BURIED IN THAT MASS OF DOCUMENTS EVEN MORE ASTONISHING THAN A MISSING CONSTITUTIONAL AMENDMENT, I CAN WELL ASSURE YOU.***

TITLES OF NOBILITY

In seeking to rule the world and destroy the United States, bankers committed many

crimes. Foremost among these crimes were fraud, conversion, and plain old theft. To escape prosecution for their crimes, the bankers did the same thing any career criminal does. They hired and formed alliances with the best LAWYERS and JUDGES money could buy. These alliances, originally forged in Europe (particularly in Great Britain), spread to the colonies, and later into the newly formed United States of America. Just as with Dharma and Oberli's legal case--the adversary lawyer, Mr. Horn, simply removes any papers from the file which can aid and assist the defendants! When discovered, he then threatens all sorts of heinous consequences if his trick is revealed. What is this man's name? I thought you would never ask: It is spelled STEVEN HORN. ONE OF HIS THREATS IS TO "GET THEM" IF THIS INCIDENT IS REVEALED IN ANY OF THIS SO-CALLED "DHARMA'S" WRITINGS. WELL, OLD BUDDY--THEY HAVE NOTHING TO LOSE BUT I DO SUGGEST THAT MR. HORN DOES!

Remember the part of the Protocols about providing witnesses sufficient to win your case? Well, he did that too--but he outsmarted himself. The first hearing came with sufficient "provided" witnesses to swamp the court with liars. But, he had presented a backup case petition which caused the Judge to disallow further proceedings at that time. So, along with the presentation of the City Clerk and City Treasurer as defendant's witnesses, the "liars" did panic and disappear. How handy, though, our attorneys have turned up one or two of them and we shall see how well they like lying NOW.

Despite their criminal foundation, these alliances forged in Europe generated wealth and, ultimately, respectability. Like any modern unit of organized crime, English bankers and lawyers wanted to be admired as "legitimate businessmen". As their criminal fortunes grew so did their usefulness, so the British monarchy legitimized these thieves by granting them **"TITLES OF NOBILITY"**.

Historically, the British peerage system referred to knights as **"Squires"** and to those who bore the knight's shields as "Esquires". (Isn't this fun?) As lances, shields, and physical violence gave way to more civilized means of theft, the pen grew mightier (and far more profitable) than the sword, and the clever wielders of those pens (bankers and lawyers) came to hold titles of nobility. The most common title was "Esquire" (used, even today, by lawyers!).

INTERNATIONAL BAR ASSOCIATION

In Colonial America, attorneys trained attorneys but most held no "title of nobility" or "honor". There was no requirement that one be a lawyer to hold the position of district attorney, attorney general, or judge; a citizen's "counsel of choice" was not restricted to a lawyer; there were no state or national bar associations. The only organization that certified lawyers was the International Bar Association (IBA), chartered by the King of England, headquartered in London, and closely associated with the international banking system. Lawyers admitted to the IBA received **the rank "ESQUIRE"--A "TITLE OF NOBILITY"!**

"Esquire" was the principle title of nobility which the 13th Amendment sought to PROHIBIT from the United States. Why? Because the loyalty of "Esquire" lawyers was suspect. Bankers and lawyers with an "Esquire" behind their names were agents of the monarchy, members of an organization whose principle purposes were political, not economic, and regarded with the same wariness that some people today reserve for members of the KGB or the CIA.

Article I, Sect. 9 of the Constitution sought to prohibit the International Bar Association (or any other agency that granted titles of nobility) from operating in America. But the Constitution neglected to specify a penalty, so the prohibition was ignored, and agents of the monarchy continued to infiltrate and influence the government (as in the Jay Treaty and the US Bank charter incidents). Therefore, a "title of nobility" amendment that specified a penalty (loss of citizenship) was proposed in 1789, and again in 1810. The meaning of the amendment is seen in its intent to prohibit persons having titles of nobility and loyalties to foreign governments and bankers from voting, holding public office, or using their skills to subvert the government.

HONOR

The missing Amendment is referred to as the "title of nobility" Amendment, but the second prohibition against "honour" (honor), may be more significant.

The archaic definition of "honor" (as used when the 13th Amendment was ratified) meant anyone "obtaining or having an advantage or privilege over another". A contemporary example of an "honor" granted to only a few Americans is the privilege of being a judge: Lawyers can be judges and exercise the attendant privileges and powers; non-lawyers CAN NOT.

By prohibiting "honors", the missing Amendment prohibits any advantage or privilege that would grant some citizens an unequal opportunity to achieve or exercise political power. Therefore, the second meaning (intent) of the 13th Amendment is to ensure political equality among all American citizens, by prohibiting anyone, ***EVEN GOVERNMENT OFFICIALS, from claiming or exercising a special privilege or power (an "honor") over other citizens.***

This interpretation is quite true, little ones, and would be the key concept in the 13th Amendment. Why? Because, while "titles of nobility" may no longer apply in today's political system, the concept of "honor" remains relevant.

For example, anyone who had a specific "immunity" from lawsuits which were not afforded to all citizens, would be enjoying a separate privilege, an "honor" and would therefore forfeit his right to vote or hold public office. Think of the "immunities" from lawsuits that your judges, lawyers, politicians, and bureaucrats currently enjoy. As

another example, think of all the "special interest" legislation your government passes: "special interests" are simply euphemisms for "special privileges" (honors).

WHAT IF?

If the missing 13th Amendment were to be restored, "special interests" and "immunities" would be rendered unconstitutional. The prohibition against "honors" (privileges) would compel the entire government to operate under the same laws as the citizens of your nation. Without their current personal immunities (honors), your judges and I.R.S. agents would be unable to abuse common citizens without fear of legal liability. If the 13th Amendment were restored, your entire government would have to conduct itself according to the same standards of decency, respect, law, and liability as the rest of the nation. If this Amendment and the term "honor" were applied today, your government's ability to systematically coerce and abuse the public would be all but eliminated. Just IMAGINE!

CAN YOU IMAGINE A GOVERNMENT WITHOUT SPECIAL PRIVILEGES OR IMMUNITIES? How could you even describe it? It would be almost like a government--OF THE PEOPLE---BY THE PEOPLE---AND FOR THE PEOPLE! COULD IT POSSIBLY BE THAT THE FOUNDING FATHERS INTENDED IT BE THAT WAY? IMAGINE: A GOVERNMENT WHOSE MEMBERS WERE TRULY ACCOUNTABLE TO THE PUBLIC; A GOVERNMENT THAT COULD NOT SYSTEMATICALLY EXPLOIT ITS OWN PEOPLE!

It's unheard of for it got deliberately undone before it could be done--it has never been done before--and you thought a poor soul called Benedict Arnold was a traitor! You have never had a Constitutional government as intended--not ever in the entire history of the world!!!

So here comes the argument: Senator George Mitchell of Maine and the National Archives concede this 13th Amendment **was proposed by Congress in 1810**. However, they *explain that there were seventeen states when Congress proposed the "title of nobility" Amendment; that ratification required the support of thirteen states, but since only twelve states supported the Amendment, it was not ratified*. The Government Printing Office hops on the bandwagon to agree; it currently prints copies of the CONSTITUTION OF THE UNITED STATES which include the "title of nobility" Amendment as proposed--**but un-ratified**.

Even if this 13th Amendment was never ratified, even if research would be flawed and only twelve states voted to ratify the Amendment--wouldn't the possibility be wondrous to imagine? So what am I saying? Am I saying that it was a dream within one vote of historical utopia? No! I am saying that it WAS RATIFIED.

After a break we shall continue to prove it. And, dear ones of America and ones running for office with overwhelming odds against "housecleaning"--**here are your tools to do the sweeping! NOW DO YOU SEE THE VALUE OF A GOOD OLD**

SPACE CADET WITH X-RAY VISION? IT SURELY DOESN'T SURPRISE ANY OF YOU THAT THIS PARTICULAR AMENDMENT WOULD "GET LOST"? SO BE IT.

CHAPTER 6

REC #2 HATONN

FRIDAY, AUGUST 30, 1991 11:27 A.M. YEAR 5, DAY 014

PARADISE FOUND?

Again, I give humble thanks and appreciation to David Dodge and Alfred Adask for jobs well done!

In 1789, The House of Representatives compiled a list of possible Constitutional Amendments, some of which would ultimately become your Bill of Rights. The House proposed seventeen; the Senate reduced the list to twelve. During this process Senator Tristrain Dalton (Mass.) proposed an Amendment seeking to prohibit and provide a penalty for any American accepting a "title of Nobility" (RG 46 Records of the U.S. Senate). Although it wasn't passed, this was the first time a "title of nobility" amendment was proposed.

Twenty years later, in January, 1810, Senator Reed proposed another "Title of Nobility" Amendment (*History of Congress, Proceedings of the Senate*, p. 529-530). On April 27, 1810, the Senate voted to pass this 13th Amendment by a vote of 26 to 1; the House resolved in the affirmative 87 to 3; and the following resolve was sent to the states for ratification:

"If any citizen of the United States shall Accept, claim, receive or retain any title of nobility or honour, or shall, without the consent of Congress, accept and retain any present, pension, office or emolument of any kind whatever, from any emperor, king, prince or foreign power, such person shall cease to be a citizen of the United States, and shall be incapable of holding any office of trust or profit under them, or either of them."

The Constitution requires three-quarters of the states to ratify a proposed amendment before it may be added to the Constitution. When Congress proposed the "Title of Nobility" Amendment in 1810, there were seventeen states, thirteen of which would have to ratify for the Amendment to be adopted. According to the National Archives, the following is a list of the twelve states that ratified, and their dates of ratification.

(Herein please note that the 16th (income tax) Amendment was truly never ratified! But here you have one which was truly ratified with proof thereof--and it was secretly heisted from your Constitution—are you getting a bit upset yet?)

Maryland, Dec. 25, 1810

Kentucky, Jan. 31, 1811

Ohio, Jan. 31, 1811
Delaware, Feb. 2, 1811
Pennsylvania, Feb. 6, 1811
New Jersey, Feb. 13, 1811
Vermont, Oct. 24, 1811
Tennessee, Nov. 21, 1811
Georgia, Dec. 13, 1811
North Carolina, Dec. 23, 1811
Massachusetts, Feb. 27, 1812
New Hampshire, Dec. 10, 1812

NOW WATCH THE "NOW" USUAL SLEIGHT OF HAND AND FOOTWORK FOR IT HAS BECOME THE MODUS OPERANDI WHEN THE GOING GETS TIGHT: **Before the thirteenth state could ratify, the WAR OF 1812 BROKE OUT WITH ENGLAND.** By the time the war ended in 1814, **THE BRITISH HAD BURNED THE CAPITOL, THE LIBRARY OF CONGRESS, AND MOST OF THE RECORDS OF THE FIRST 38 YEARS OF GOVERNMENT.** I'm sure the connection between the proposed "title of nobility" amendment which would close England out of the US government forever, and the War of 1812 BECOMES SELF-EVIDENT! You have entered massive wars for far less--like Desert Storm in Iraq.

Four years later, on December 31, 1817, the House of Representatives resolved that President Monroe inquire into the status of this Amendment because all sorts of "strange" things were beginning to happen in your government. In a letter dated Feb. 6, 1818, President Monroe reported to the House that Secretary of State Adams had written to the governors of Virginia, South Carolina and Connecticut to tell them that the proposed Amendment had been ratified by twelve States and rejected by two (New York and Rhode Island), and asked the governors to notify him of their legislature's position. (House Document No. 76)

(This, and other letters written by the President and the Secretary of State during the month of February, 1818, note only that the proposed Amendment had not YET been ratified. **However, these letters would later become crucial because, in the absence of additional information, they would be interpreted to mean that the amendment was never ratified.**)

On February 28, 1818, Secretary of State Adams reported the rejection of the Amendment by South Carolina (House Doc. No. 129). There are no further entries regarding the ratification of the 13th Amendment in the Journals of Congress; whether Virginia ratified is neither confirmed nor denied. Likewise, a search through the executive papers of Governor Preston of Virginia does not reveal any correspondence from Secretary of State Adams. **(However, there is a journal entry in the Virginia House that the Governor presented the House with an official letter and documents from Washington within a time frame that includes receipt of Adams' letter.)** Again, however, no evidence of ratification; none of denial.

Whoopee! However, on March 10, 1819, the Virginia legislature passed Act No. 280 (Virginia Archives of Richmond, "misc." file, p. 299 for micro-film): ***"Be it enacted by the General Assembly, that there shall be published an edition of the Laws of this Commonwealth in which shall be contained the following matters, that is to say; the Constitution of the (u)nited States and the amendments thereto...."*** This act was the specific legislated instructions on what was, by law, to be included in the republication (a special edition) of the Virginia Civil Code. The Virginia Legislature had already agreed that all Acts were to go into effect on the same day--the day that the Civil Code was to be republished. Therefore, the 13th Amendment's official ***DATE OF RATIFICATION WOULD BE DATE OF RE-PUBLICATION OF THE VIRGINIA CIVIL CODE: MARCH 12, 1819!!!***

The Delegates knew Virginia was the last of the 13 States that were necessary for the ratification of the 13th Amendment. They also knew there were powerful forces allied against this ratification so they took **extraordinary measures to make sure that it was published in sufficient quantity (4,000 copies were ordered, almost triple their usual order), and instructed the printer to send a copy to President James Monroe as well as James Madison and Thomas Jefferson. (The printer, Thomas Ritchie, was bonded. He was required to be extremely accurate in his research and his printing, or he would forfeit his bond.)**

IN THIS FASHION, VIRGINIA ANNOUNCED THE RATIFICATION: BY PUBLICATION AND DISSEMINATION OF THE THIRTEENTH AMENDMENT OF THE CONSTITUTION.

Some argue that there is question as to whether Virginia ever formally notified the Secretary of State that they had ratified this 13th Amendment. Some have argued that because such notification was not received (or at least, not recorded), the Amendment was therefore not legally ratified. However, printing by a legislature is prima facie evidence of ratification.

Further, there is no Constitutional requirement that the Secretary of State, or anyone else, be officially notified to complete the ratification process. The Constitution only requires that three-fourths of the states ratify for an Amendment to be added to the Constitution. If three-quarters of the states ratify, the Amendment is passed. Period. The Constitution is otherwise silent on what procedure should be used to announce, confirm, or communicate the ratification of amendments.

Knowing they were the last state necessary to ratify the Amendment, the Virginians had every right to announce their own and the nation's ratification of the Amendment by publishing it on a special edition of the Constitution, and so they did.

Word of Virginia's 1819 ratification spread throughout the states and both Rhode Island and Kentucky published the new Amendment in 1822. Ohio first published in 1824. Maine ordered 10,000 copies of the Constitution with the 13th Amendment to be

printed for use in the schools in 1825, and again in 1831 for the Census Edition. *Indiana Revised Laws* of 1831 published the 13th Article on p. 20. Northwestern Territories published in 1833. Ohio published in 1831 and 1833. Then came the Wisconsin Territory in 1839; Iowa Territory in 1843; Ohio again in 1848; Kansas Statutes in 1855; and Nebraska Territory six times in a row from 1855 to 1860.

So far, Dodge has identified eleven different states or territories that printed the Amendment in twenty separate publications over forty-one years. And more editions including this 13th Amendment are sure to be discovered for they ARE THERE WAITING!

So--you might be able to convince some of the people, or maybe even all of them, for a little while, that this 13th Amendment was never ratified. Maybe you can show them that the ten legislatures which ordered it published eighteen times (known) consisted of ignorant politicians who don't know their amendments from their...ahh, articles. You might even be able to convince the public that your forefathers never meant to "outlaw" public servants who pushed people around and accepted bribes or special favors to "look the other way". Maybe. But before you do, there is a lot of evidence to be explained.

THE AMENDMENT DISAPPEARS

In 1829, the following note appears on p. 23, Vol. 1 of the *New York Revised Statutes*:

"In the edition of the *Laws of the U.S.* before referred to, there is an amendment printed as article 13, prohibiting citizens from accepting titles of nobility or honor, or presents, offices, etc., from foreign nations. But, by a message of the president of the United States of the 4th of February, 1818, in answer to a resolution of the House of Representatives, it **appears** that this amendment had been ratified only by 12 states, and therefore had not been adopted. See vol. iv of the printed papers of the 1st session of the 15th congress, No. 76." (Emphasis added.) In 1854, a similar note appeared in the *Oregon Statutes*. Both notes refer to the *Laws of the United States*. 1st vol. p.73/74.

It's not yet clear whether the 13th Amendment was published in *Laws of the United States*, 1st Vol., prematurely, by accident, in anticipation of Virginia's ratification, or as part of a plot to discredit the Amendment by making it appear that only twelve States had ratified. Whether the *Laws of the United States* Vol. 1 (carrying the 13th Amendment) was re-called or made-up is unknown. In fact, it's not even clear that the specified volume was actually printed--the Law Library of the Library of Congress has no record of its existence.

However, because the notes' authors reported no further references to the 13th Amendment after the Presidential letter of February, 1818, they apparently assumed the ratification process had ended in failure at that time. If so, they neglected to seek information on the Amendment after 1818, or at the state level, and therefore missed

the evidence of Virginia's ratification. This opinion--assuming that the Presidential letter of Feb.1818, was the last word on the Amendment--has persisted to this day.

In 1849, Virginia decided to revise the 1819 *Civil Code of Virginia* (which had continued the 13th Amendment for 30 years). It was at that time that one of the code's revisers (**A LAWYER NAMED PATTON**) wrote to the Secretary of the Navy, William B. Preston, asking if this Amendment had been ratified or appeared by mistake. (A most interesting resource for information at any circumstance.) Preston wrote to J.M. Clayton, the Secretary of State, who replied that this Amendment was not ratified by a sufficient number of States. This conclusion was based on the information that Secretary of State J.Q. Adams had provided the House of Representatives in 1818, BEFORE Virginia's ratification in 1819. *(Funny thing--and take careful note: today, the Congressional Research Service tells anyone asking about this 13th Amendment this same story: that only twelve states, not the requisite thirteen, had ratified. Skunks in the woodpile?)*

Note, however, **that despite Clayton's opinion, the Amendment continued to be published in various states and territories for at least another eleven years (the last known publication was in the Nebraska Territory in 1860).**

Once again the 13th Amendment was caught in the riptides of American politics. South Carolina seceded from the Union in December of 1860, signalling the onset of the Civil War. In March, 1861, President Abraham Lincoln was inaugurated.

Later in 1861, another proposed amendment, also numbered thirteen, was signed by President Lincoln. This was the only **proposed** amendment that was ever signed by a president. That resolve to amend read: "**ARTICLE THIRTEEN, No amendment shall be made to the constitution which will authorize or give to Congress the power to abolish or interfere, within any State, with the domestic institutions thereof, including that of persons held to labor or service by the laws of said State**" (In other words, President Lincoln had signed a resolve that would have permitted slavery, and upheld states' rights.) Only one State, Illinois, ratified this proposed amendment before the Civil War broke out in 1861.

In the tumult of 1865, the original 13th Amendment was finally removed from your Constitution. On January 31, another 13th Amendment (which prohibited slavery in Sect. 1 and ended states' rights in Sect. 2) was proposed. On April 9, the Civil War ended with General Lee's surrender. On April 14, President Lincoln (who, in 1861, had signed the proposed Amendment that would have allowed slavery **and states rights**) **was assassinated**. On December 6, the "new" 13th Amendment loudly prohibiting slavery (and quietly surrendering states rights to the federal government) was ratified, replacing and effectively erasing the original 13th Amendment that had prohibited "titles of nobility" and "honors". Wasn't that about as clever as you can get?

SIGNIFICANCE OF REMOVAL

To create the present **oligarchy (rule by LAWYERS) which you now endure**, the lawyers first **had to remove the 13th "titles of nobility" Amendment that might otherwise have kept them in check**. In fact, it was not until after the Civil War and after the disappearance of the 13th Amendment that the newly developing bar associations began working diligently to create a system wherein lawyers took on a title of privilege and nobility as "**Esquires**" and received the "**honor**" of offices and positions (like district attorney or judge) that **only** lawyers may now hold. By virtue of these titles, honors, and special privileges, lawyers have assumed political and economic advantages over the majority of U.S. citizens. Through these privileges, they have nearly established a two-tiered citizenship in this nation where a majority may vote, but only a minority (lawyers) may run for political office. This two-tiered citizenship is clearly contrary to Americans' political interests, the nation's economic welfare, and the Constitution's egalitarian spirit.

The significance of the 13th Amendment and its deletion from the Constitution is this: Since the amendment was never lawfully nullified, it is **still** in full force and effect and is the Law of the land. If public support is awakened, this missing Amendment would provide a legal basis to challenge many existing laws and court decisions previously made by lawyers who were unconstitutionally elected or appointed to their positions of power; it might even mean the removal of lawyers from your current government system.

At the very least, this missing 13th Amendment demonstrates that two centuries ago, lawyers were recognized as enemies of the people and nation. Some things never change.

THOSE WHO CANNOT RECALL HISTORY

In his farewell address, George Washington warned of "...change by usurpation; for though this, in one instance, may be the instrument of good, it is the customary weapon by which free governments are destroyed."

In 1788, Thomas Jefferson proposed that you have a Declaration of Rights similar to Virginia's. Three of his suggestions were "freedom of commerce against monopolies, trial by jury in ALL cases" and "no suspensions of the habeas corpus."

No doubt Washington's warning and Jefferson's ideas were dismissed as redundant by those who knew the law. Who would have dreamed your legal system would become a monopoly against freedom when that was one of the primary causes for the rebellion against King George III?

Yet, the denial of trial by jury is now commonplace in your courts, and habeas corpus, for crimes against the state, suspended. (By crimes against the state, I refer to "political crimes" where there is no injured party and the corpus delicti--evidence--is equally imaginary).

I had a document handed into Dharma's hands not 15 minutes ago from the Christic Institute, entitled *Avirgan v. Hull Update*.

It starts off (and I shall write just a tiny portion): ***Ruling disregards evidence, denies right to trial by jury. On June 18 three judges of the 11th Circuit appeals court refused to reinstate Avirgan v. Hull, a civil racketeering lawsuit charging 29 members of a criminal racketeering enterprise with murder, destruction of property, drug trafficking, gun smuggling, money laundering and other crimes. The judges upheld two decisions handed down by Judge James Lawrence King of Miami: An order granting "summary judgements" in favor of the defendants and a subsequent ruling ordering the Christic Institute, General Counsel Daniel Sheehand and Plaintiffs Tony Avirgan and Martha Honey to pay more than \$1 million in punitive fines for allegedly filing the lawsuit "in bad faith". The Institute has asked all 11 judges of the appellate court to review the decision. If necessary, we plan to appeal to the Supreme Court....***"

Just a bit more from this same case: *Judge King's decision to halt proceedings shortly before the trial's scheduled opening date predicated on an argument unprecedented in law: that plaintiffs are NOT ENTITLED TO THEIR CONSTITUTIONAL RIGHT TO A TRIAL BY JURY UNLESS THEY SUBMIT ALL OF THEIR EVIDENCE TO THE JUDGE IN ADMISSIBLE FORM BEFORE THE TRIAL BEGINS.*

It goes on and on but I haven't space here to handle that subject also. In other words, however, you have to have and prove each of the accusations to the "judge" BEFORE the lawsuit can be filed. Grounds for objection: ***"A judge is prohibited from this conduct when a plaintiff has formally demanded a trial by jury."***

The authority to create monopolies was judge-made law by Supreme Court Justice John Marshall, et al., during the early 1800's; Judges (and lawyers) granted to themselves the power to declare the acts of the People "un-Constitutional", waited until their decision was grandfathered, and then granted themselves a monopoly by creating the bar associations.

Although Art.VI of the U.S. Constitution mandates that executive orders and treaties are binding upon the states ("...and the Judges in every State shall be bound thereby, anything in the Constitution or Laws of any State to the Contrary notwithstanding."), the Supreme Court has held that the Bill of Rights is not binding upon the states, and thereby resurrected many of the complaints enumerated in the Declaration of Independence, exactly as Thomas Jefferson foresaw in "Notes on the State of Virginia", Query 17, p.161, 1784:

"Our rulers will become corrupt, our people careless... the time for fixing every essential right on a legal basis is {now} while our rulers are honest, and ourselves united. From the conclusion of this war we shall be going downhill. It will not then be necessary to resort every moment to the people for support. They will be forgotten,

therefore, and their rights disregarded. They will forget themselves, but in the sole faculty of making money and will never think of uniting to effect a due respect for their rights. The shackles, therefore, which shall not be knocked off at the conclusion of this war, will remain on us long, will be made heavier and heavier, till our rights shall revive or expire in a convulsion."

So, you await the inevitable convulsion.

Only two questions remain: Will you fight to revive your rights? Or will you meekly submit as your last remaining rights expire, surrendered to the courts, and perhaps to a "New World Order"?

There was an addendum to this information which must be added: Documentation has been sent as to five more editions of statutes that include the Constitution and the missing 13th Amendment.

These editions were printed by: Ohio, 1819; Connecticut (one of the states that voted against ratifying the Amendment), 1835; Kansas, 1861; and the Colorado Territory, 1865 and 1867.

These finds are important because: 1) they offer independent confirmation of these claims; and 2) they extend the known dates of publication from Nebraska, 1860 (Dodge's most recent find and herein mentioned as such), to Colorado in 1867.

The most intriguing discovery was the 1867 Colorado Territory edition which includes **both the "missing" 13th Amendment AND the current 13th Amendment (freeing the slaves), on the same page. The current 13th Amendment is listed as the 14th Amendment in the 1867 Colorado edition.**

Now in appreciation for this material I ask reprinting of the following:

This investigation has followed a labyrinthine path that started with the questions about how our courts evolved from a temple of the Bill of Rights to the current star chamber and whether this situation had anything to do with retiring chief Justice Burger's warning that we were "about to lose our constitution". My seven year investigation has been fruitful beyond belief; the information on the missing 13th Amendment is only a "drop in the bucket" of the information I have discovered. Still, the research continues, and by definition, is never truly complete.

If you will, please check your state's archives and libraries to review any copies of the Constitution printed prior to the Civil War, or any books containing prints of the Constitution before 1870. If you locate anything related to this project we would appreciate hearing from you so we may properly fulfill this effort of research. Please send your comments or discoveries to:

David M. Dodge, P.O. Box 985, Taos, New Mexico 87571.

Please, you other researchers, like Patrick B.--get on this and share up what you find. You will only turn this nation around through the LAW AND IT IS ALL THERE IF YOU BUT UNCOVER AND RECOVER IT. SALU.

I have only one more tid-bit to dump on you in the "you are had" category for this writing: In uncovering the mess with the conspiracy regarding Santa Barbara Savings/RTC/Bank of America fraud and deceit involving Dharma and Oberli--it is uncovered that the following practice is common and takes place with the RTC in massive proportion these days: A bank, say, Bank of America, buys from the RTC, Santa Barbara Savings--BUT--THEY ONLY GET THE GOOD ASSETS AND THE RTC (YOU-THE-PEOPLE) CARRY ALL LOSSES AND CONTESTED PROPERTY. IN OTHER WORDS IT IS COMPLETELY PRE-ARRANGED THAT THE BANK(ERS) GET ALL THE ASSETS AND YOU TAKE THE DEBTS! GOOD-LUCK, WORLD! Note that this property in question is already overshadowed by expenses against its value two to one from litigation--but in the end you-the-people will hold the bag. By the way, once again, there is found to be a deadline (which is hidden from view) in which you must file an (unknown) form by a certain date or you are forever barred from any claim. Is it not about time you do something about this fraud and plague upon your lands?

I further wish to acknowledge a publication which I admire greatly for it is **DEDICATED TO RAISING HELL FOR LAWYERS!** If you have a good story please send it to them--we'll get around to it, too. If you can write, if you've got a personal story about the legal system to tell, an essay to publish on injustice, or a letter to the editor, they want it. They can't pay you for it--but freedom is worthy of giving unity. The editor urges you to write and not pussyfoot around--don't let the system scare you into silence--name names, send photo copies of relevant documents, pictures of yourself or the principal parties, and say what's in your heart as well as what's in your legal dictionary. They look for documents anywhere from letter-size on up to 2,000 word essays (Well, ours is about 300,000 words, so guess it will have to be in shorthand!).

YOU CAN CHANGE THINGS IF YOU WANT TO--OR YOU CAN SIT AND WAIT AND IT WON'T MATTER ANY MORE.

THESE PEOPLE CALL THEIR PUBLICATION: AntiShyster, 9794 Forest Lane, Suite 159, Dallas, Texas 75243. 1-800-477-5508. Their slogan: IT'S NATIONAL ATTORNEY WEEK--TAKE A SHYSTER TO LYNCH.

In the meanwhile, anyone wanting to write up this particular case in point--we will be delighted! We are most happy to give a whole bunch of names and places. You are going to find the same ones that continually pop up in the news--Bush, Reagan, Shea & Gould, Salomon Bros, etc. The network is so massive that a "clean sweep" with your Constitutional broom is all that will do it. God Bless!

Hatonn to clear.

CHAPTER 7

REC #2 GERMAIN

SATURDAY, AUGUST 31, 1991 7:59 A.M. YEAR 5, DAY 015

SATURDAY, AUGUST 31, 1991

Germain present in this wondrous day of experience. May we walk always in the Radiance of His Holy Light.

THE PURPOSE OF THE CUBE IN NATURE

We have carefully described the purpose of the sphere in creating this curved universe of dynamic motion by dividing the static universe of no motion into light-waves.

These light-waves are thus permitted to multiply the cold condition of space into heat by the aid of biconvex lenses and to divide the heat into cold by the aid of concave ones.

The cube enables light-waves to repeat themselves by the use of light mirrors of zero curvature. The tools which built Creation are, therefore, light-**projecting** lenses and mirror-**reflecting** planes. (See Fig. 48)

Power projection means the wireless transmission of power generated from anywhere to wherever one wishes to project it. This power is of utmost value to science because it enables it to build missiles with which it can strike any designated section of another country, and also to build anti-missiles which find and destroy missiles sent from other countries. No, I am NOT in the missile building business but you have a whole bunch aimed at you and a network of them aimed each at the other, everywhere on your globe. These are for war usage; but for peacetime usage, power could be projected from one power plant to another without the necessity of using hundreds of thousands of miles of wire transmission cable. **Nature does not use wires to maintain that tremendous cosmic intercommunication system which links every creating thing to every other creating thing. This enables us to say that there are no two separate or separable things in all this universe: there is but ONE. It thus demonstrates the ONENESS of all things and creatures in this universe.**

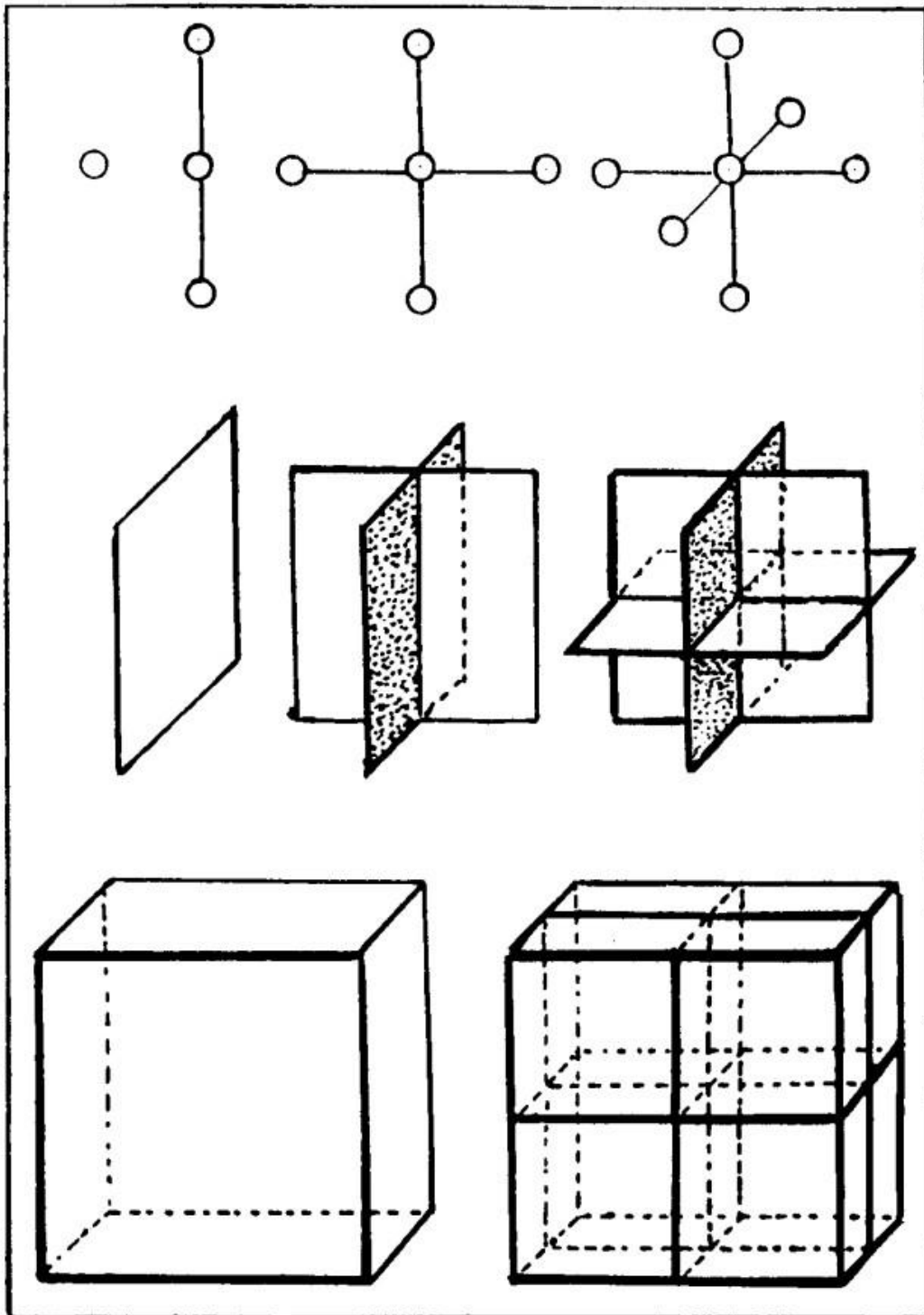

FIG. 48 Illustrating how the nine mirror planes of the cube are built up from zero by polarized extension. All nine planes are at angles of 90 degrees from each other. They consist of the three inner planes which intersect the cube and the six faces which bound it.

On the yesterday I was, of necessity, quite abrupt with Wally G. for which I apologize. It was urgent that Hatonn have the use of the "hands" which will be abundantly clear as you ones read the information about the "MISSING 13TH AMENDMENT--REMOVED FROM YOUR U.S. CONSTITUTION DELIBERATELY--WHICH BARS LAWYERS FROM GOVERNMENTAL POSITIONS OF TRUST AND SERVICE!"

What I do wish to say to Wally and any of you who have a definite "purpose" and know that which it is--please bear with US. I appreciate your desires to go and investigate, honor and look up details about ones with whom I share and funnel information. I must ask, however, that you refrain from rushing out and becoming sidetracked UNLESS I TELL YOU TO DO SO. What I give you, as in the case of Wally (and this writing and drawings will also be sent to him immediately), is that which you need. Further, it is the only information from this beloved author which is of technical value. This is not to diminish the giving of any being--it is to keep ones with purpose from being confused and further distracted. This is what we of the Hosts are--sorters of information in TRUTH from the haystack.

Mr. Russell's work is excellent, but like so many other points of projection, parts of that work become totally absorbed by outside influence and "only" the technical output is untampered and worthy in its remaining form. The "New Age" "searchers" have managed to usurp into a metaphysical "center" his wondrous contribution and that of his most beautiful spouse. Therefore, I ask all of you who work within my tutelage with intent to "build" from that which "I" give in technical information--please trust me enough to understand that I have chosen very carefully that which is needed to complete a task or bring it to the point of readiness for the next key. **THE ONE IMPORTANT THING--UPON WHICH EVERYTHING IS STALLED--IS WORKING SCRIPT AND PRELIMINARY INFORMATION TO FINANCE SIPAPU--ALL ELSE, INCLUDING CAMERA TECHNOLOGY, IS OF NO IMPORTANCE WHATSOEVER AT THIS TIME. THE INFORMATION, WALLY, IS TO ALLOW THE "SEEDS" TO GERMINATE WITHIN AND THE ANSWERS WILL APPEAR WHEN THE SEQUENCE IS PROPER. PLEASE, DEAR ONES, STOP PUSHING THE RIVER! ALSO, I URGE YOU ONES WHO RECEIVE SPECIAL INFORMATION AND DIRECTION--BE MOST CAREFUL WITH WHOM YOU SHARE IT IN TECHNICAL DISCUSSIONS FOR ALL OF YOU ONES HAVE PROVEN THAT YOU CANNOT TELL ENEMY FROM FRIEND--AND MANY WILL TAKE YOUR WORK AND SIMPLY STEAL IT FROM YOU. SO BE IT.** There is another point which I shall have to make very clear, indeed. If you have great babble you jeopardize our very lives, also, for this information has another use of utmost importance. This knowledge gives the ability to control the landing places of astronauts in space satellites, and to make use of balloon-like satellites for telephone projection to distant countries and even to automobiles on the roads. You have basically a "reverse" idea of

proper equipment structuring for maximum use without necessity of atomic thrust systems and high use of energy for operation.

All of this is made possible **because science has learned to control gravity** to quite a considerable extent even though it is not aware that it has done so. We have mentioned this in a prior lesson when speaking of the eminent scientist who said he believed it would be possible some day to attain knowledge on how to control gravity. In that same lesson, we discussed the **making of a gravity-powered reactor which would eliminate the use of atomic energy and give unlimited heat, at almost no expense, by using generated surplus and, thereby, getting continuous power without the use of current from a power plant.**

We herewith print another diagram, Fig. 49, which analyzes the different sections of the cube by taking it apart. The sections marked "B" and "BB" show how the cube is divided into six geometric forms, known as tetrahedrons, which control the static universe of stillness, and the sections marked "D" and "DD" show it divided into six cones which control the curved universe of motion by revolving spirally within the static cube.

Study this Fig. 49 with us as we proceed. The closing spirals--these generate energy from the cold of space to heat it through compressing invisible light into visible light by thrusting inward from without--occupy just two tetrahedrons; but the radiating spirals--these revolve in one centering plane on the equators of the suns thus produced--revolve within the other four tetrahedrons and create the gravity fields which science calls "magnetic fields".

We now refer you to the cube marked "A". Note that it is bounded by its six planes and intersected by three planes, all at right angles, as marked "1". "2" shows the ONE cube divided into EIGHT, and therein lies the mathematical basis of pressures in Nature. Falling bodies multiply the power of compression eight times that which they were when they began falling. This is known in mathematics as of the cube in inverse ratio. For rising bodies, it is known as of the cube in direct ratio.

Now, by adding the zero position, which is the central part of the cube where matter has reached its maximum compression and heat, we derive our decimal system of 1 - 2 - 3 - 4 - 5 - 6 - 7 - 8 - 9 (10 becomes 1 again), the ninth being the anode of the wave and the first and last being its two cathodes and equators of reversal or points of rest.

We again refer to the diagram and note in C that the six circles drawn on the six faces of the cube are conical lines reaching toward the cube center. These conical lines relate to the curved universe of motion, as clearly shown in "D" and "DD". In "D" only four are shown for to show the other two would be impossible. We, therefore, expand them in perspective at "DD" to make it possible.

Now we come to a vitally important fact. The cube of six flat faces ALONE can crystallize in the forms of the cube and its intersections. They represent the static

universe. Conical surfaces cannot crystallize in their forms because they represent the transient, curved, ever changing universe of motion.

We will now consider another phase of universal mathematics for which we print Figs. 50 and 51. We have placed these on opposite pages where you can compare each with the other. In mathematics, we have what are known as three dimensions. (We will not yet deal with fourth dimension equations for you must make workable objects within this three dimensional experience--the fourth will then take care of itself, as you will see, for the fourth only relieves the confusion of wear and operation "compression". Further, we don't need expertise in the fourth dimension expression for we already have the operational technology). These three represent the tonal pressures of the octaves. The octaves of the elements begin with a zero group which is known as the inert gases. The first dimension represents that pressure tone which is represented in the carbon octave, lithium **and** fluorine, the **first** equally divided mate pair. The second dimension represents the **second** equally divided pair which is known as beryllium and oxygen. The third dimension is represented by boron and nitrogen, the **third** equally divided mate pair of this sex-divided universe of motion.

Now we come to an unknown fact of Nature which gives a fourth dimension and which must be considered herein, and that is represented in its octave as carbon and on the bar magnet as the end poles. Carbon is NOT a pair as the others are. It is a union OF ALL THE OTHER PAIRS MELDED INTO ONE. Carbon and its prototypes are at the wave amplitudes. In carbon are all of the colors of the spectrum united as ONE and the entire nine lens-producing spectrum of both curvatures, convex and concave. This entire octave and the other eight octaves add up to but one meaning and the meaning is universal ONENESS OF THE ONE THING--LIGHT. That includes the ONE BROTHERHOOD of man, all the species and all things else. It means that there are no two separate or separable things in all the universe, and it also means that LOVE is the basis of Creation, which leads us to the door of the CREATOR for God is LIGHT and also LOVE.

Oberli, I ask that "Chuck" receive this same special information which I am giving up front to Wally. And then, please see to it that he gets all pertinent information--we want him familiar with these concepts like the back of his hand. He will not be given into full understanding for it is not time for him to fill his purpose and I want no confusion. He will have to cleanse his mind of that which is already in it and that will be difficult enough without added burden. Thank you, for much will be given to him to further the ideas Paul was being given at his demise. Concern not about it--just provide the information.

There is one other fact about crystallization that has never been understood. That fact is that as the octaves progress from the carbon octave--which has no hole in it as the previous octaves have in which densities multiply from the inside-out, whereas the octaves which have closed their holes increase their densities from the outside-in, which means from outward toward their centers within--they complex their crystal forms. The cube form of the carbon octave complexes to hexagonal, and each

succeeding octave complexes still more, to octahedral and so on, until the complexity increases so much that in the niton inert gas it has no reflecting mirrors to multiply light-power inward. It still compresses but becomes so weak that the explosive power intensifies to incandescence. There it explodes to the speed of light which is 186,400 miles per second. All visible incandescent light, back to the fourth octave, reaches that speed of light also. That is because the fourth octave is the first of the nine to have closed its hole. From there on, all amplitude elements of succeeding octaves, which have no holes in them, multiply their speed to 186,400 miles per second. From wave amplitudes, invisible light flows backward to the first octave through its inert gases.

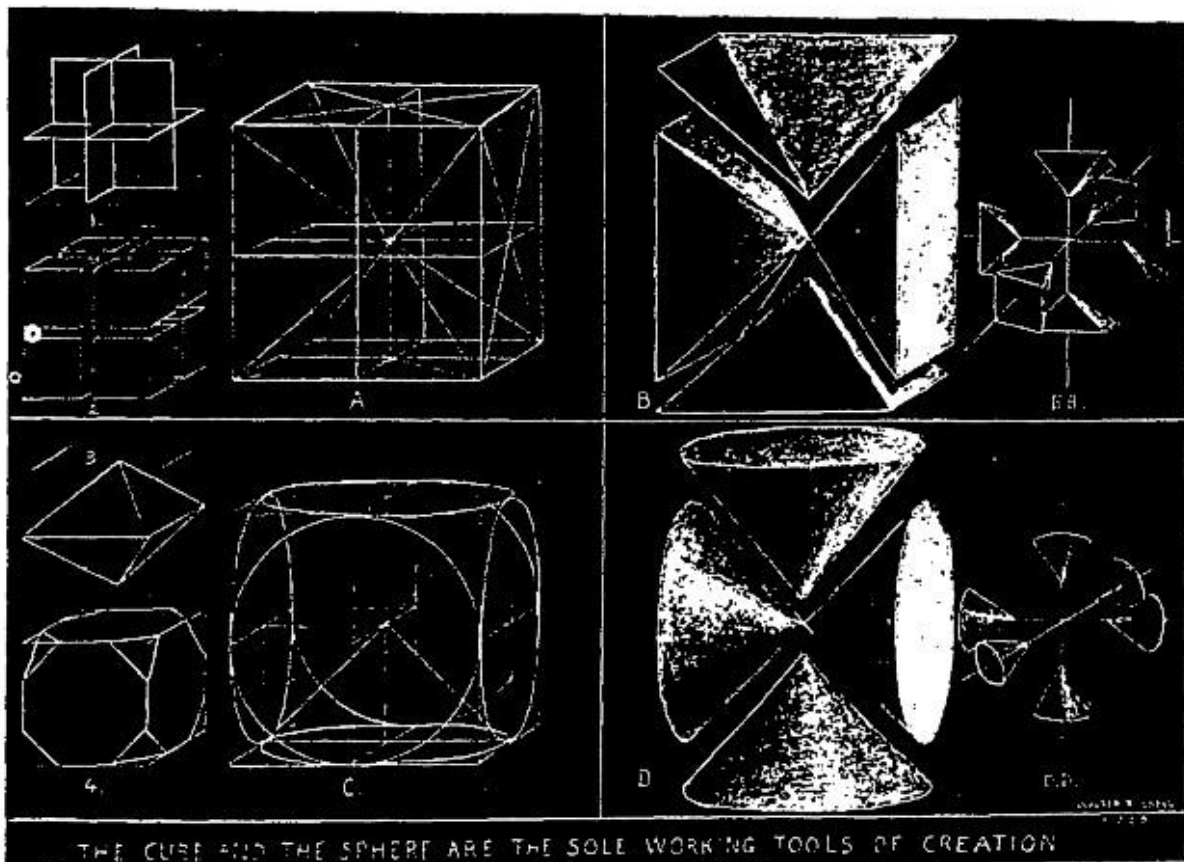

FIG. 49. This diagram illustrates the manner in which the cube controls the curved universe of motion from its static condition. Within its tetrahedrons, its spirals revolve as cones in two of them while in the central four, the spirals revolve within one plane to create the gravity fields which are known as magnetic fields.

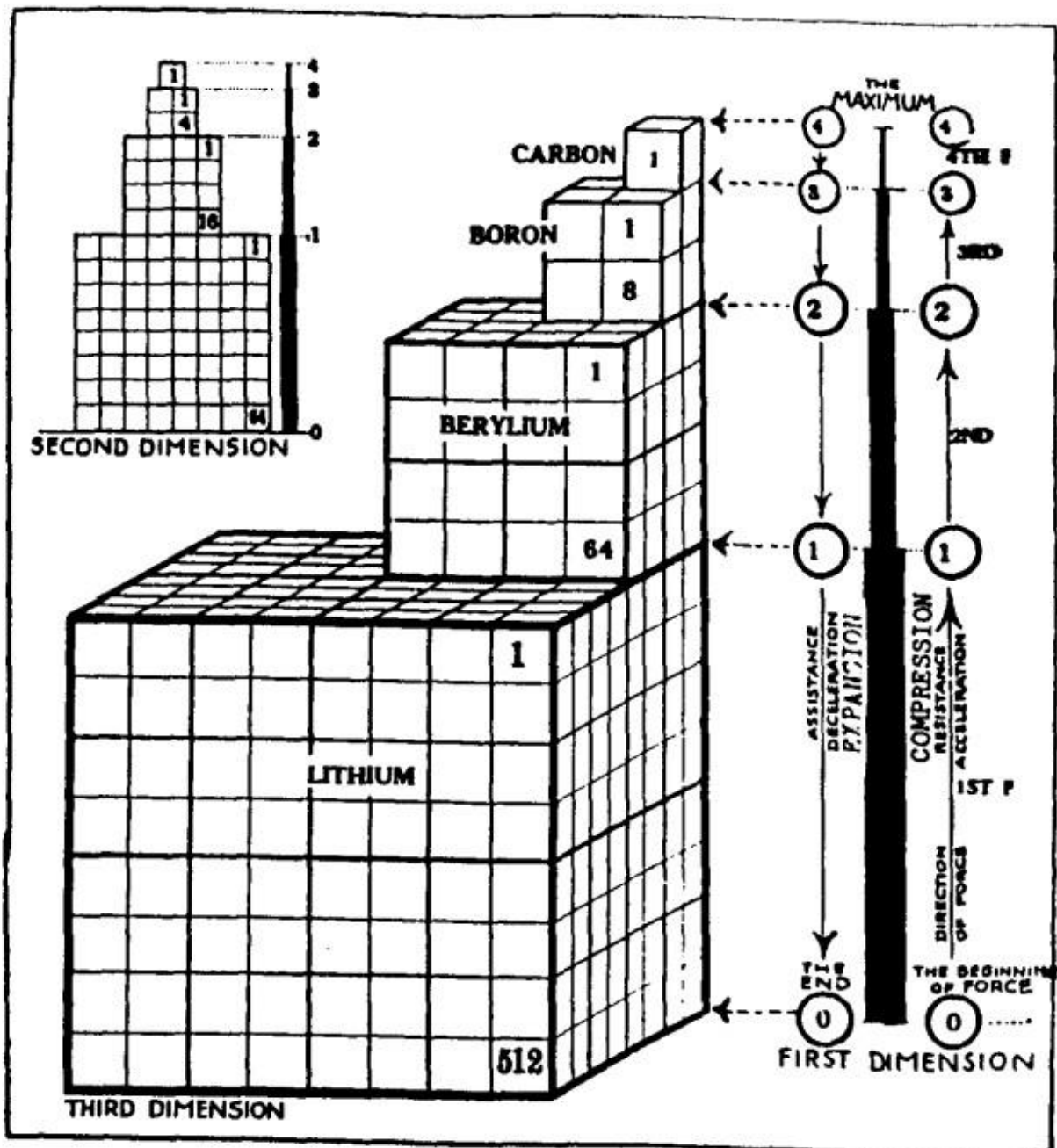

FIG. 50
 ALL DIMENSIONS ARE BASED UPON
 TONAL RELATIONS IN OCTAVE WAVE FIELDS

possible.

Now we come to a vitally important fact. The cube of six flat faces alone can crystalize in the forms of the cube and its intersections. They represent

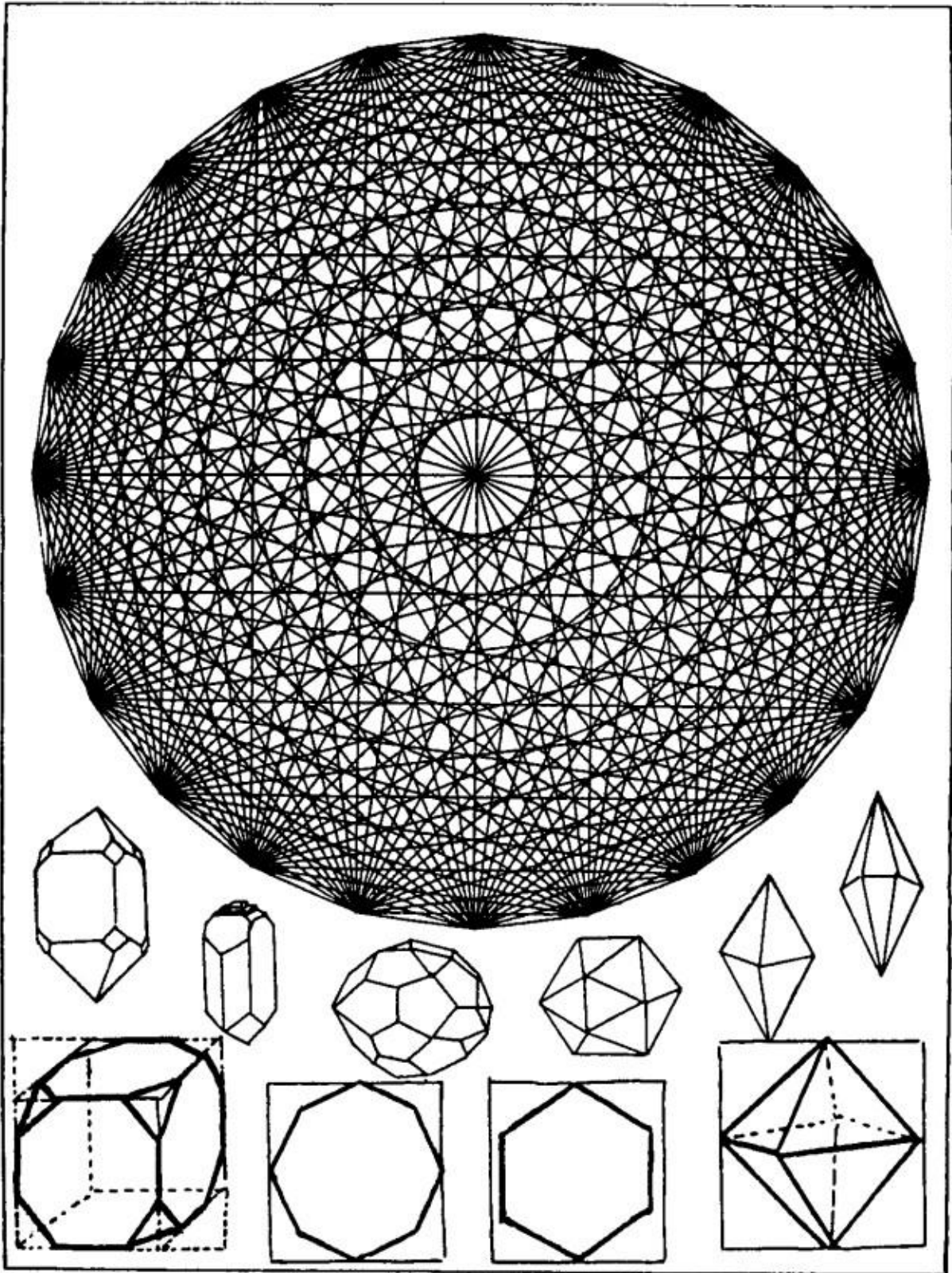

FIG. 51

ALL FORMS OF ALL BODIES ARE BASED UPON THE CUBE-SPHERE
AND ITS INTERSECTIONS.

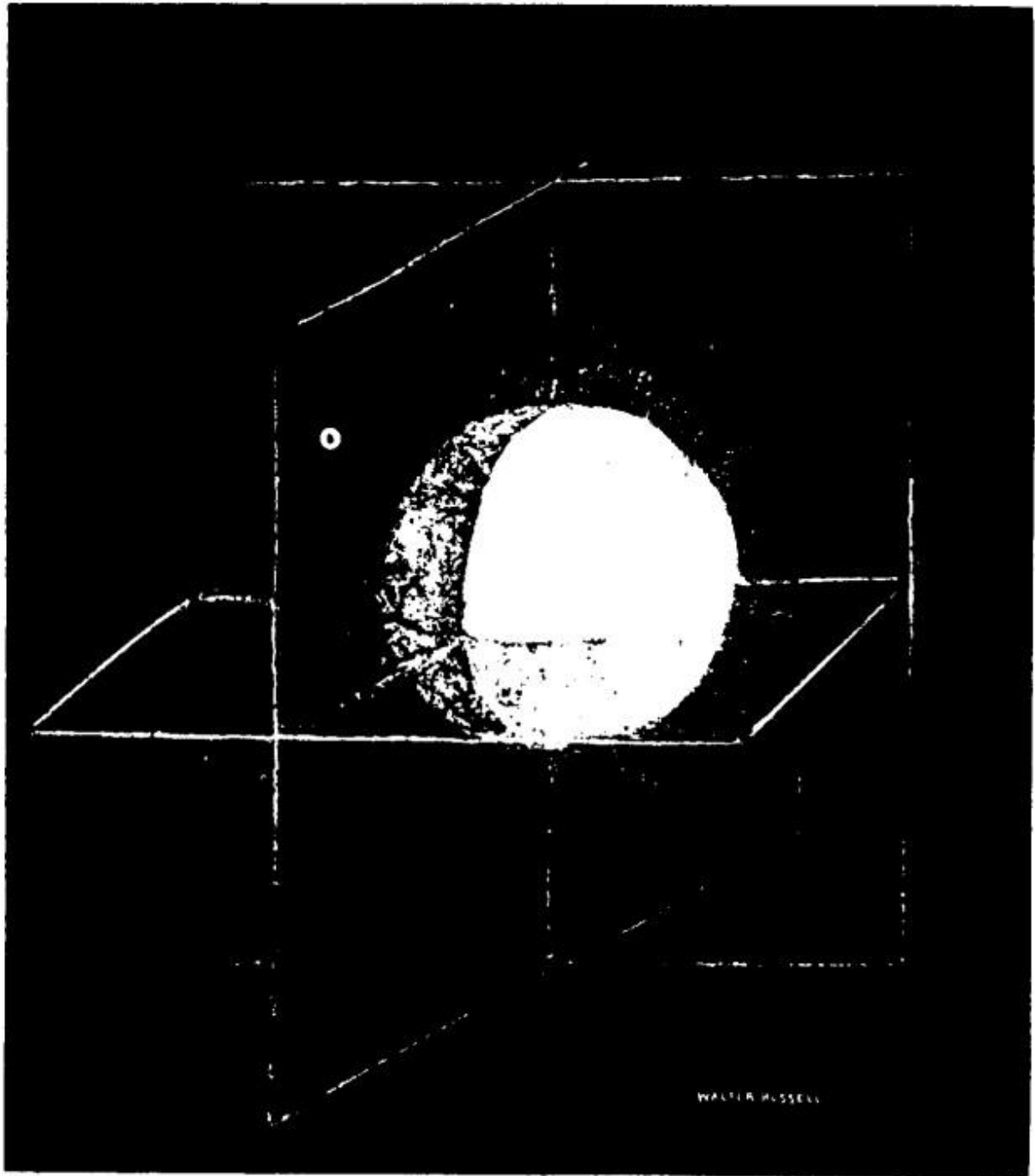

FIG. 52

This diagram represents the radar intercommunication system of Nature. Its purpose is to tell everything in the universe what is happening everywhere else in the universe. There is nothing more powerful to demonstrate UNIVERSAL ONENESS than this diagram of the intercommunication system of Nature.

Within the incandescence of the cube form lies the secret of atomic energy! And, yes, for you precious ones such as E.J., Bufe and D. who wrote on the calendar many years ago that D. would receive the clues of Tesla--here it is. If you can understand the concept laid forth herein (which very few will be allowed to do) you have it.

There is one more reason why Science must know about the power of the cube before we close this lesson--that is, the production of that universal effect called "radar". Radar is the great intercommunication system for recording all effects of motion and repeating them to all other effects in the universe at the speed of light. Fig. 52 illustrates this effect.

Note that each section of the sphere centers one of its eight cubes at the intersection points of its eight divisions and its three intersecting planes, all of which are at right angles to each other. Each of these sections projects light rays outward in all of the eight directions of motion in space. These directions are the four points of the compass--east, west, north and south; plus northeast, northwest, southeast and southwest.

Radar technicians give a name to the eight corners where they divide the sphere into eight sections. They call them "corner receivers" and recite them as a power in radio. **They are not only receivers but reflectors, or projectors, or transmitters. Their radars are based on this principle but they make use of only one in building their radar machines. There is no reason why five of them should not be used. They would cover the four points of the compass and the azimuth without the necessity of sweeping the horizon. There is no need for using the other three corners as it is not necessary to direct the flow to the earth's surface.**

This concludes our first brief summary of the fundamentals of your new look at your universe. Therefore, I ask for a short break for refreshment and then we will march right along into and through the wondrous NATURE OF LIGHT!

I AM --- GERMAIN

CHAPTER 8

REC #3 GERMAIN

SATURDAY, AUGUST 31, 1991 9:54 A.M. YEAR 5, DAY 015

NATURE OF LIGHT

Throughout the last several chapters we emphasized the following facts:

1. That every effect is an optical effect;
2. That every action-reaction--such as inbreathing and out-breathing, compression and expansion--is two-way, not one-way, which means that this is a reciprocating, continuous, pendulum-swinging universe of rhythmic balanced interchange between the cold stillness of space and the compression-heated moving universe;
3. That it is a universe of repetitive uphill and downhill flow and that the "expanding universe" is inconsistent with Nature's processes;
4. That, as a consequence, the present laws of thermodynamics necessarily picture a dying, heat-death universe known as "entropy" instead of an **eternal** one created by an eternal God;
5. That gravity is the controller of light and that light is the ONE THING in all Nature;
6. That science has mistaken magnetism for gravity and light-waves are known as "electricity";
7. Finally, that every effect is a photographic effect made by opening-closing diaphragms of the Cosmic Camera which makes this universe an **optical, photosynthetic universe** of gravity-controlled light instead of the electro-magnetic universe of the present era's concept.

We might have added to this list that atoms were not solid spheres but only empty ones with holes in them which had to become closed before they could become solid. They, therefore, had no nuclei until they reached their wave amplitudes where they were united as one complete spectrum unit. They then divided into pairs where they could reproduce themselves as father and mother pairs of the sexed universe.

We might also have laid more emphasis on the fact that although two curvatures were the only tools for creating this curved universe of matter, just one tool (the

cube) is used for repeating these pulsations of interchanging between the two curvatures.

We will now take another great step forward in opening the doors of knowledge to the nature of light by again referring to the misconception about parallel rays of light which, if true, could never make invisible light visible by twisting them spirally together.

Up to the date of the issuance of this original information, science knew no way of dividing this undivided universe of invisible light--which the Creator is--into pairs of opposites of the spectrum. This was intentional in its absence of acceptance of this when originally given, for those who did utilize the information have been banished and/or the information used for negative adversarial purposes. I imagine that it is quite clear to you by now, that the Russians were the first to accept the new scientific input that we now bring.

Pairs of opposites of the spectrum, which are necessary to create this repetitive universe of pulsing motion, function by heating cold into varying temperatures to create the elements of matter, which again freeze to hold them in that state and which man may further heat or dissolve in order to fill his needs. From there, they then return to the cold of their Source in space by the slow process of radiation, as all bodies do.

The KNOWER who created pulsing light of living bodies gave man another way of dividing light by creating **darkness** for him. Eyes were given him with limited vision. These eyes were able to see but a short segment of visible light bodies. Beyond them, all light was invisible to their vision.

Darkness, therefore, was given man as another way of dividing the undivided. You will know what we mean by day and night sequences by turning off the lights in your room. You can no longer SEE light because it is beyond your range of vision, but you KNOW that it is still there. It is the ONE THING which can never be extinguished. **In the same sense, you cannot SEE God but you can KNOW that God is behind all the orderliness which Creation IS.**

Science has long known that a pinhole punched in a cardboard enclosure surrounding darkness would expand rays of visible light into a series of light rings within which the holes were larger in the center and grew smaller toward their outside. Science terms them "diffraction rings" and wonders why they thus split up into rings instead of continuing as parallel rays of light. **If photographed in color, it would be seen that the centering hole would be blue, as it is in the Lyra ring in the heavens, and the red and yellow would be on the outside rim. This means that density increases from inside toward the outside, and this characterizes all expanding masses.**

Now, as to the reason WHY they thus expand, which science admittedly does not know. Science forgets that the rays which entered that pinhole were compressed into their brilliant visibility by gathering them from large areas and winding them in

centripetal spirals. That is what compression does. As soon as those compressed light rays, which were gathered from the darkness and multiplied, entered the **darkness** of the pinhole camera, they necessarily divided, for we again repeat that **darkness divides heat rays into cold as well as its own radiation divides it.**

One might ask why darkness divides the light rays of radiating fires of the sun and then doubt it because he believes that solids like wood and stone do not thus dissolve. But they do. **Even the stones deep down in the dark earth dissolve into water by cold wetness flowing to the earth's surface to cool as well as to combine with the rays of the fiery sun. They, likewise, have been cooled by the cold darkness of space to the temperatures required by the earth to grow things.** The very planet then takes its turn in being dissolved in the same manner and absorbs its water to further disintegrate the planet. The absorbed water even takes its own turn and disintegrates into the lower water gases of earlier octaves such as methane.

Returning to the subject of your earth, you have seen stones crumbled by wet coldness and wood by wet dampness and by dry rot from its heat. Residents and visitors of London have seen stones of centuries-old buildings crumble to the extent where their surfaces could be scratched off with one's finger tips.

Let us study the two opposite pairs of compression and expansion as we proceed. (See now, Figs. 53 and 54.)

Fig. 53 is the type of wave which begins with a hole and endeavors to close its hole by intersecting other hollow wave spheres to form biconvex lenses to aid it. Science terms these intersecting waves "wave interferences" and makes no explanation of their vast importance in furnishing the two curved tools which the Creator alone uses to create this curved universe of motion.

It is this type of light ring which gives birth to the other type, for we again repeat that compression begets expansion and expansion begets compression. Together, these two opposite curvatures are equal mates as fathers and mothers are equal mates. They occupy opposite sides of the spectrum and interchange to create other equal father and mother opposites. Such interchange unites both opposites as ONE to create other opposite father and mother pairs to continue this universe of motion into eternity. **It manifests the balanced equality of the sex principle as the very foundation of this dynamic universe of motion.**

Let us now refer to Fig. 54. We first observe HOW and WHY compression begets expansion and vice versa. If one throws a compressed mass such as a stone into water, it will beget the Figure 54 type of wave. Note that the compression causes the opposite mate to be centered with shorter and higher waves which expand to greater distances apart as they recede from that center. This should not be difficult for you to understand for it should be familiar to you from your childhood. You can see the same effect when a fish captures an insect upon the water's surface.

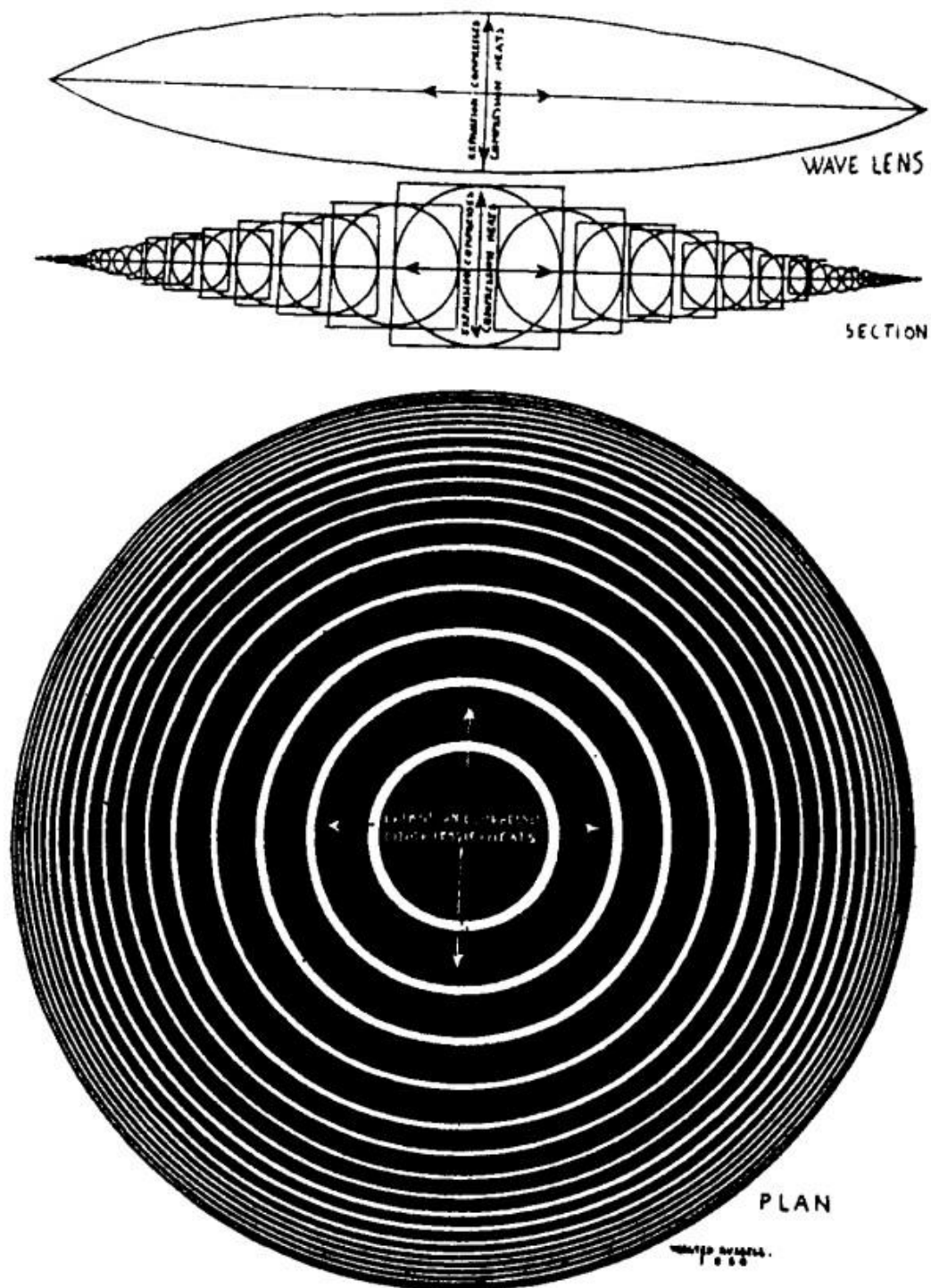

CATHODE LIGHT-MULTIPLYING COMPRESSION RINGS.

FIG. 53 This type of ring forms the zero cathodes of cold beginnings. They are the product of the tool of Creation controlled by biconvex lenses.

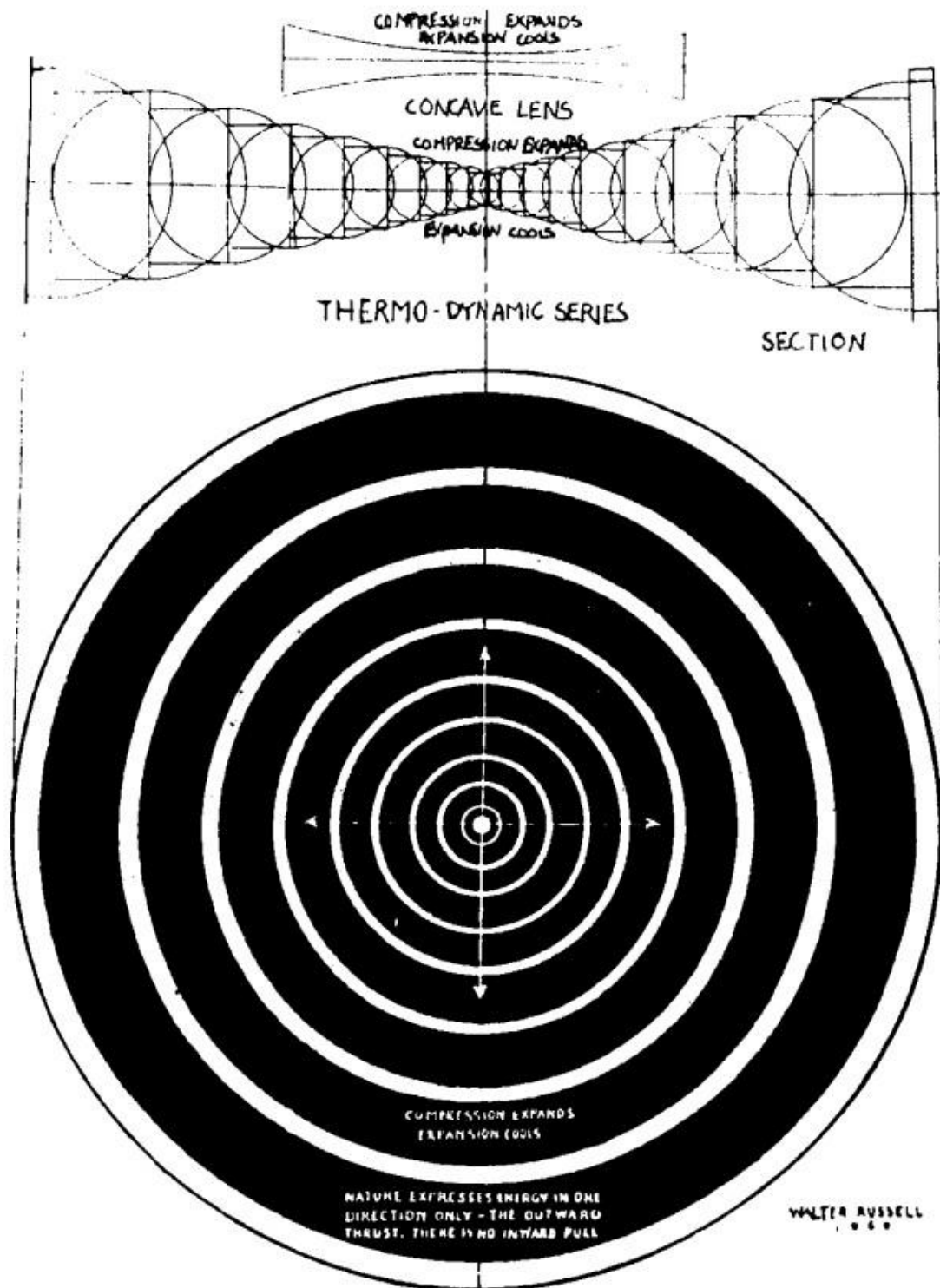

ANODE LIGHT-DIVIDING EXPANSION RINGS

FIG. 54 This type of ring forms the hot anodes of the wave amplitudes where heat collides. They are the product of biconcave lenses.

Here is another example of nature's processes to help clarify the meaning of that pinhole camera. That cardboard through which the hole has been punched is an equator which divides compression from expansion. If you will observe the waves of water as they approach a hole in a cliff or a hole between rocks in a running brook, you will see curved waves closing inward as they near that hole and piling up above the water level, then dropping in foamy bubbles which become more foamy as the drop becomes deeper.

That spells out the meaning that compression is the cause and expansion is the **effect** of that closing. Science, however, uses the words "diffraction" and "refractions" for similar effects **of that same cause**. Our point in this discussion is to prove that science uses those terms "diffraction" and "refraction" in many other effects of a similar nature.

It uses the word "reflection" where light strikes in a pool of water. A straight line seems to extend between the wall and the bottom of the pool. That line is curved, however, for the potential of pressure increases at every succeeding level. **Once more we repeat that there cannot be a straight line of light rays, or parallel lines, in a curved universe, as textbooks on optics constantly claim.**

Another point we have repeatedly claimed is that compression and expansion are the only forces which keep this curved universe in continuous motion. Without them, this hot universe of compressed light would return to its static state of cold. For this reason, we have entitled our drawings, Fig. 53: CATHODE LIGHT-MULTIPLYING COMPRESSION RINGS and Fig. 54: ANODE LIGHT-DIVIDING EXPANSION RINGS.

Now, it must be known that the biconvex lens, which controls compression, focuses outside of itself to create heat in four efforts at its four foci. When these four efforts combine with the opposite sides of the sun to create the octaves of the elements, their combined heat foci create a complete sphere. Maximum heat for that octave is then in the center of both biconvex and biconcave curvatures. Until then, both curvatures focus on the outside, but when both curvatures have created a true sphere, the biconcave lens becomes the centering one. The other six lenses are known as meniscus lenses. These seven lenses then begin to thin at their centers and holes return to oblate the planets or suns until their masses eventually become rings and disappear in the **outside dark** of cold space by the same process as living bodies do when they "die" and disappear in the **inside dark** of the earth. That is why people bury dead bodies. Dead bodies give life to the seed of living bodies. That is how things grow. It is the very life principle of repetitive Nature.

This brief explanation of the principle of growth brings us back to the cosmic cinema motion picture which is this universe, and explains the illusion which the universe of motion also is. It further explains why this universe is a photosynthetic one where

every mind picture of its thinking process disappears into its dark interval for rebirth into another sequential picture until the **idea** it represents is completed. Then the cube mirrors of dark space repeat that sequence of pictures in another **idea** cycle of life. As gravity is the desire force which controls mind-thinking, it gives another reason why this universe of motion should be called an optical universe of gravity-controlled light. The fact that every **thought-wave** picture dissolves every one of its sequences into the still zero of these sequences proves the validity of our own law which says that **every action-reaction of motion is voided as it occurs, is repeated as it is voided and recorded as it is repeated**. This also proves that the whole of Creation is still and that nothing really happens except **thought and desire of Mind to manifest thought** by taking its one Idea of Creation apart and dividing it into many ideas.

In this manner, we are gradually unfolding the secrets of the universe cosmically and endeavoring to point the way for man to think beyond what his eyes can see.

We will outline and diagram the principles and techniques of power projection, transmutation and the ability to use gravity and the multiplied heat from the sun as solar energy at the close of this series of lessons.

We now return to a step-by-step explanation of the build-up of light and heat from the curved compression lenses that are centered by holes which cause density to increase from inward to outward to those which become solid spheres where density increases from the outside inward.

Fig. 55 diagrams the first step in explaining this multiplying principle. Now study Fig.56 from the top diagram down as we proceed. The diagram marked "a" exemplifies a gravity bar--*which has been wrongly known as a bar magnet*. **This diagram "a" represents Nature's method of dividing the undivided cold dark stillness of the universal equilibrium into divided pairs of opposites to which Nature gives motion for the purpose of interchanging in order to enable them to unite and repeat their division.** As the old positive and negative symbols do not picture this process--for one is not plus and the other minus, but equal mates instead--we were obliged to use the plus (+ +) for both red and blue sides of the spectrum. We used the double plus (+ +) to indicate the poles of maximum compression and heat to fit the new conception of this curved, moving universe. The arrows symbolize the direction of motion. The double plus ((pencil in symbol)) symbol represents the poles of unity where the collision takes place which unites them.

The second diagram, marked "b", very clearly indicates the wave intersections (interferences) which multiply light by adding the power of the largest lens to each succeeding smaller one. This multiplies each one in the inverse cube ratio. **You will note three pairs of foci on each side of the cathode zero and a fourth pair--which is a pair in one--in the sun thus multiplied from its zero to 8 - 64 -512 - and 4096 powers. That gives to Nature its compression principle which makes its uphill flow of energy possible. Take special note that the wave spheres from which the lenses are taken reduce in the same ratio.**

To explain the numbers 8 - 64 - 512 - 4096, compute mathematically what is known as the square and the cube in inverse and direct ratio. The question is one of pure mathematics, not of matter.

In the third diagram, marked "c", we have made a "close-up" of only two of the lenses in order to better emphasize the position of the maximum heat which maximum compression makes possible.

As you will see in the charts given in later pages, the first four elements of the first four octaves have not yet closed their holes. The fifth element of the fourth octave is carbon. In this element, the hole is closed. It then reverses and increases its density and heat from the outside in. In and after the fourth and up to the ninth octave beginning with carbon, all of the elements are solid. These elements are able to eject their multiplied electrons with ever-increasing speed until they reach the ninth octave where radium, neptunium and others of that octave are enabled to eject their multiplied electrons with such force that they are incandescent and have obtained the speed of light. These electrons can be seen in a spintharoscope.

All of these together make up Nature's intercommunicating system by means of which every action-reaction is made so aware of every other action-reaction pulsation that it demonstrates the ONENESS of God's universe of motion as it is in its **stillness**.

In concluding this lesson, we shall give you a diagram of one complete octave of the carbon type. See Fig. 57. We regret that it is not possible to present it in full spectrum colors.

In the next lesson, we will take another step in unfolding Nature's secrets.

NOTE: We may be misunderstood throughout these lessons by stating that the word "electricity" should not be used for an "optical" universe. The word "electricity" is used for every effect of light such as your light bulbs. The word "opticity" would have no meaning for the average man.

I AM --- GERMAIN

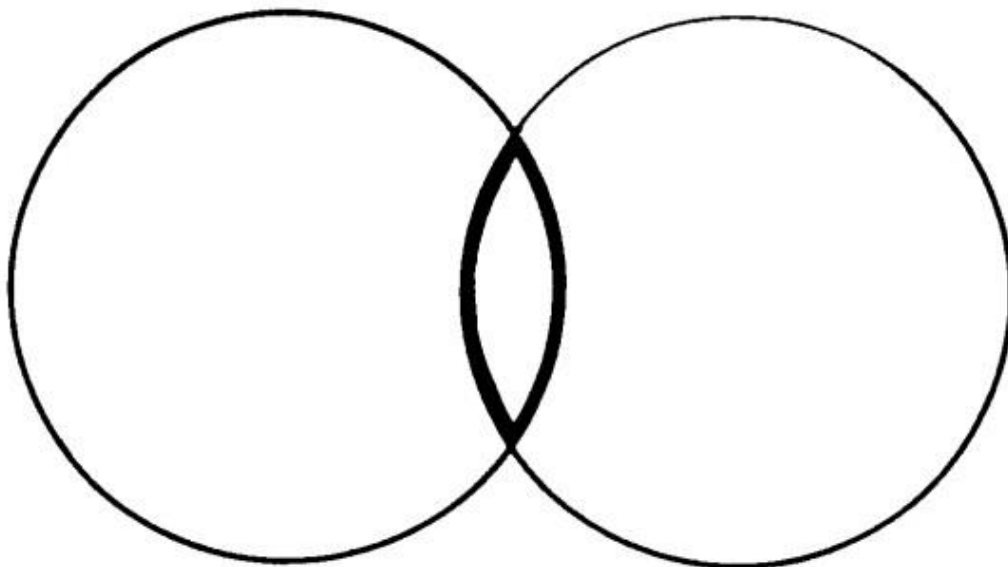

FIG. 55

This drawing shows the biconvex lens which is accountable for the compression power and heat-building which generates heat from cold. It is one of the two curvatures which the Creator makes use of to convert invisible light into visible light.

after the fourth and up to the ninth octave beginning with carbon, all of the elements are solid. These elements are able to eject their multiplied electrons with ever-increasing speed until they reach the ninth octave where radium, neptunium and others of that octave are enabled to eject their multiplied electrons with such force that they are incandescent and have obtained the speed of light.

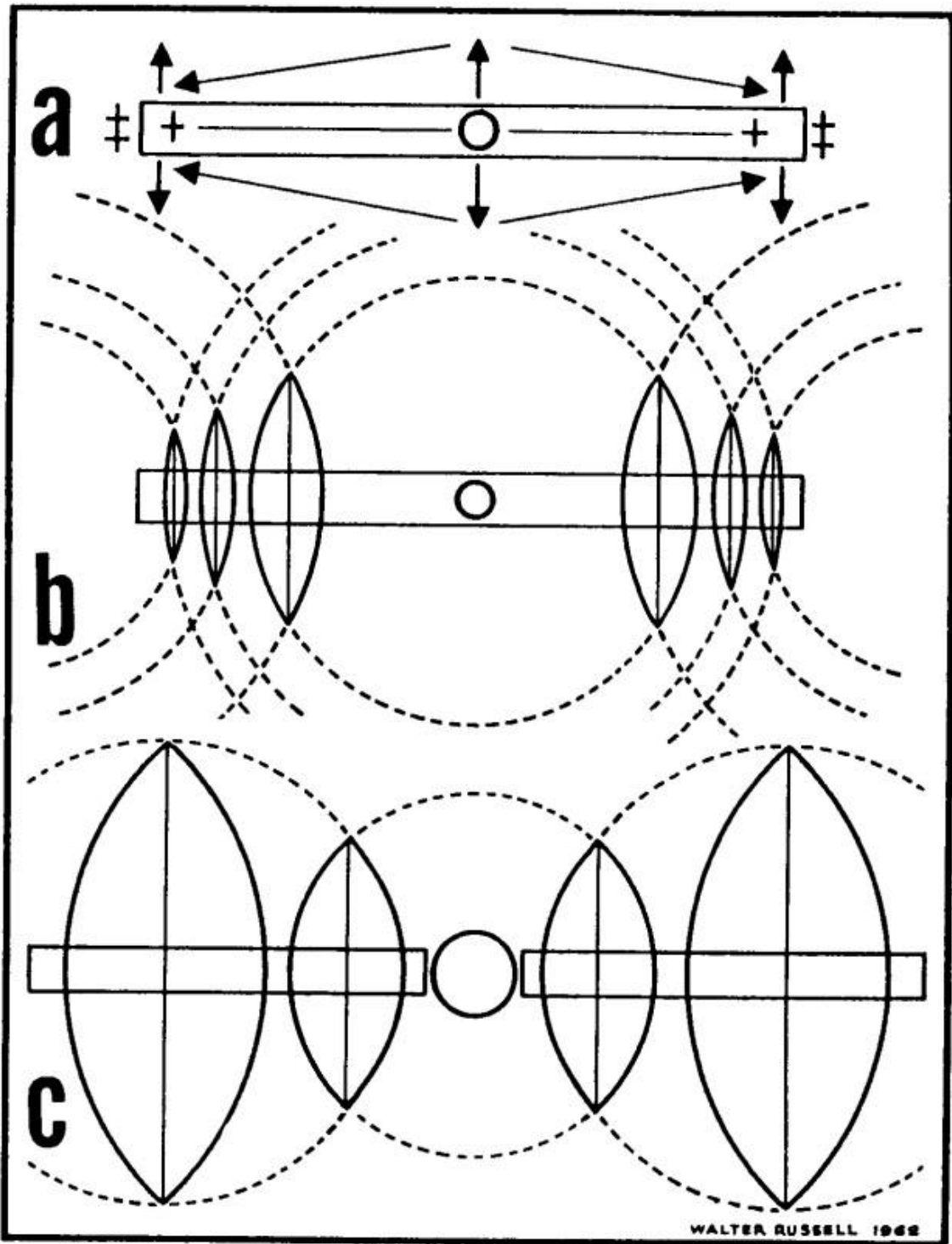

FIG. 56

Showing the entire construction principle of the octave wave, step by step.

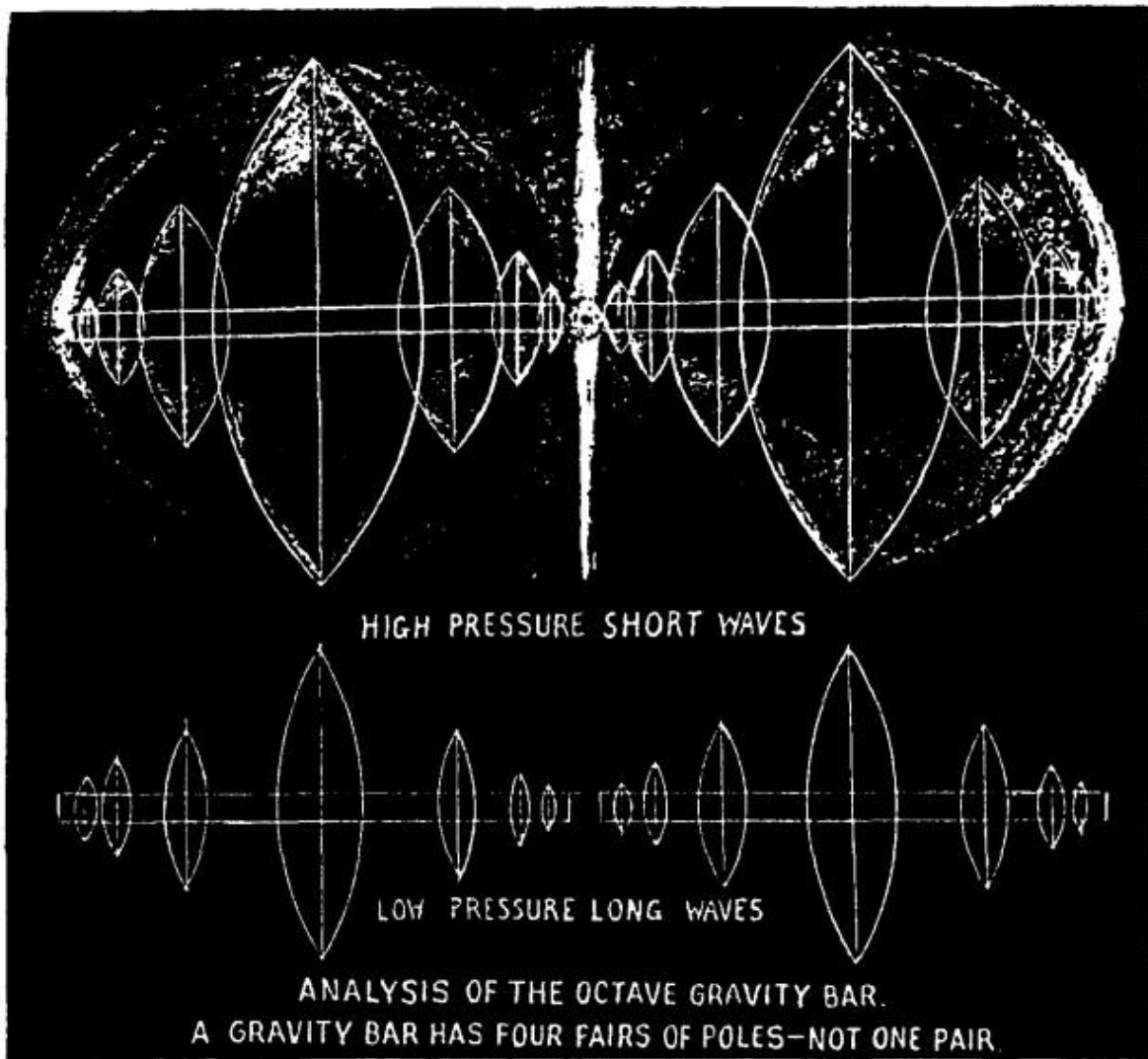

FIG. 57

This shows the complete gravity bar (bar magnet) with its entire octave sequence.

CHAPTER 9

REC #4 GERMAIN

SATURDAY, AUGUST 31, 1991 1:00 P.M. YEAR 5, DAY 015

COMPLETION: CONSTRUCTION OF WAVE PRINCIPLE

We have heretofore built up an understanding of the reason why light needs a method for transferring its **knowing** to a dynamic dramatization of the God-nature by means of moving images of the idea contained in the word "omniscient", which means all-knowledge combined in its undivided stillness in an undivided universe.

It was first necessary to describe very clearly the nature of light and especially that quality of desire in it which controlled the division of light into its spectrum colors and the cube principle which gravity made use of to repeat its cycles.

If the Creator were merely the Knower and the Thinker with desire to THINK the Father-Mother manifestation of what the Creator knows, there would be no divided universe for the very purpose of that division is to manifest the Father-Mother idea of equal pairs of opposites. This it does by dividing that ONE OMNISCIENT IDEA into countless fathers and mothers for uniting into the ONE idea by the mutual interchange of each to each other. This, in total, is the thinking principle, and the light bodies thus created by this process have no real existence other than a thought existence.

It will be noted by observers that a division into pairs must always have a balancing equator. The cube of zero curvature supplies that balancing equator. That division into idea also includes the identity of every created thing. A man's entire body is divided into symmetrically equal pairs. The head is balanced with two ears for hearing, two nostrils and two lungs for breathing, two sides of a mouth for eating or laughing, two eyes for seeing, and two arms and legs for working and walking. Even the heart has two ventricles to complete its pumping cycles.

Thus it is throughout all animal and vegetable life. Trees throw out their branches and their roots spread out equally. If a tree leans over its roots, that leaning must be counterbalanced.

That is why real knowledge of the construction of the wave and the WHY of that construction should be known. To draw conclusions based upon observed illusions is to make assumptions of truth and takes much needless time and effort from man. Even the axioms of mathematics are not **self-evident truths**, for mathematicians for centuries have made decisions which mathematicians of later years have discarded and supplemented with new ones. The Nazarene likewise said that man cannot gain knowledge by observation. Such changing "knowledge" is merely an assumption and assumptions are but information, just as food is not nourishment until it has been

digested. Encyclopedias are full of such ever-changing information which subsequent editions change to fit more modern assumptions.

The early scientists believed that the world was flat. **He could see it with his own eyes.** Those words were the belief of the ages. They still are. Ptolemy believed them and changed the whole world's belief because of it. All that was theretofore accepted as truth was thrown out of the window. Copernicus believed those words and again threw all that was theretofore known out the window. How many times that has happened during the ages up to the expanding universe and the Rutherford-Bohr construction of the atom theories, one does not know because each new concept affected the whole structure in so subtle a way that one could not positively say that the whole of it was thrown out the window.

We, however, *throw all of the combined concepts out of the window!!!* We are rewriting this revised and expanded lesson to open up your **inner vision** which lies beyond thinking. This is known as imagination and inspiration and these are the qualities which cosmic thinkers have acquired to such an extent that they can see that light of Creation within themselves with inner vision. This is a quality which Cosmic Conscious Illuminates have to a very great extent and geniuses have attained to a lesser extent.

You will grasp our meaning by such facts that geniuses such as Beethoven and Liszt can HEAR sounds where there is naught but silence and write them down in beautiful rhythmic themes to uplift the souls of other men. Neither of these two classes needs schools or universities.

The fact that such inner vision may not have yet come to you as it eventually **will** is the very reason why we print so many pictures and diagrams. Inner vision and inspiration are seen in pictures, not in words. Pictures remain in your memory for a long time while words can be forgotten in a few moments. That is our main purpose for printing so many of them and as few words as necessary to give greater understanding to the pictures. By indelibly fixing the pictures which you fully comprehend into your mind, you will slowly become a cosmic thinker. The deeper your desire is to enter that coveted realm, the more you will comprehend these pictures and the faster you will enter its doors.

Inner vision gives knowledge of the process which makes the radiation of heat from the sun gradually cool as its rays divide by the concave curvature into which these light rays from the sun increase their distance from it. The same is true about the planets surrounding the sun. Mercury is so hot that even its metals melt or glow with red hot heat. Venus is so much farther away from the sun that it has cooled sufficiently to have water upon it, but that water is so hot because of the hot planet itself that it is a thick blanket of steam which perpetually cools it.

There has been a world-wide question as to why water flowed downhill. The answer is as simple as the reason rain falls from the skies or a stone falls to the ground. The one

answer to all these questions is GRAVITY. To know the secrets of **gravity** is to know why the universe of motion exists. We trust that these lessons will clarify this mystery.

With the application of Nature's processes, true knowledge is irrefutable. That is why we are endeavoring to give a simple roadmap which leads to the doors of man's Source in space. Each step tells us that such an orderly and coordinated system as this universe of motion is must have its focus in a CREATOR who made it come into being by thinking it into being.

A convincing fact of this lies in the principle of Mind **concentration** and **decentration** which terms have parallel meaning with the terms **compression** and **expansion**.

We return, therefore, to the diagram illustration made to help you visualize effects which are based upon CAUSE. We have been able only to picture the universe by its conical aspect but not by its cubical aspect. This is because it is only possible to show two tetrahedrons of the cube at an edgewise angle but not the four faces within which the equatorial plane revolved spirally to show that expanding radiation revolves at an angle of ninety degrees from the compression of generation. To illustrate our meaning, hold a cube on the level of your eyes and you will see only one of its six sides. Holding it lower still, you will see three of its six sides.

As pictures remain in the consciousness longer than words, it is necessary to visualize the cube crystal shape as well as the conical curvature shape.

SEARCH FOR MORE SECRETS

In this section of lessons, pictures for increasing inner vision of the wave and its structure will exceed the text. We will dig more deeply into the mysteries of wave structure and this alone will bring about a new and more advanced science by giving certainty to conclusions instead of the lack of sureness of previous ages.

The first diagrams which we will describe are those which still accentuate the optical principle of the relations of curvature to the law of octave structure in Nature. **This structure multiplies cold into heat and heat into cold. Both of these spinnings endeavor to close the holes which reverses the direction of their densities.**

Diagram No. 58 demonstrates the optical principles of octave multiplication by biconvex lenses located on the gravity bar in the direction of compression. There are four pairs of these lenses which compress, each one located at octave positions in their waves in the same order as the octaves of the elements of matter are located. Take note that these are enclosed by the cubes of zero curvature instead of spheres of maximum curvature as shown in a previous diagram where curvature is necessary to continue motion.

The drawing clearly marks the location of the biconvex lenses within their cube enclosures of zero motion. Observe carefully that as compression multiplies in the

cube which encloses the largest lens, the cube itself compresses at the mathematical ratio to include the next smaller lens. This ratio follows the octave wave relation to the elements of matter which are endeavoring to multiply in each succeeding one of its nine octaves until they succeed sufficiently at the fourth octave to close the hole.

The gravity bar at the bottom of this diagram gives no indication of the four pairs of focal poles which the octave principle of the elements demands to continue motion. Take note that this principle affects the ability to transmute.

We print the next two diagrams, Figs. 59 and 60, **to illustrate the thermodynamic principle that the invisible cold white light can only become visible by extending that light in every direction to create waves. Waves are, therefore, formed by the compression of two extending lights meeting each other and overlapping in that effect which science calls "interferences".**

The sections of arcs which are thus affected cause biconvex lenses to form which focus back to their point of giving out from themselves in order to fulfill the principle of giving love out from themselves, **for God is Light and love, also, is Light. The regiving of love in equal dimension is fulfilled by the fact that the lens also focuses toward the center of the regiving wave. This dividing principle of extension of light from every point of it illustrates the Oneness of Creation by uniting pairs of identities into ONE IDENTITY. It even goes further by uniting all identities into their one Source of the Creator of all identities.**

The question of these divided pairs is the WHY of them. WHY create them? **The very simple answer to that question is that God THINKS.** God thinks but one thing. That one thing is the divine IDEA OF LOVE. Desire of Mind to divide that one Idea into many **seemingly** separate ideas is for the purpose of dynamically picturing the effects which can arise from such seeming divisions of the indivisible ONE WHOLE.

Since God is LIGHT, there is no other way of expressing the Creator's **one** Idea than in making use of the ONE THING--LIGHT--as the **silent** language needed to express those many ideas, just as man needs words of **sound** to express his many ideas. We have referred to this soundless language of light in a previous lesson. We have described how an apple, a lemon, or trees of different species have meanings of their identities by their form, their color, their odor and other unchangeable qualities, and also how each one of these separate identities loses its separate identity in each other and all of them lose their collective identities in each other. **Thus is established the fact of universal ONENESS of all identities.**

This supreme fact of universal oneness is the most difficult idea to fully comprehend. Humans live in an environment which includes all ideas of Creation and it is often impossible for even the greatest of your intellectuals to comprehend his oneness with all things. The majority of the human race thinks objectively through its senses. The few who have developed sufficient inner vision to become cosmic Conscious KNOWERS instead of outer-visioned thinkers come only once in a

thousand or more years. These illumined ones are more apt to be crucified or ignored as being reactionaries during their lifetime. Is it possible this time to grasp the opportunity--or shall ye do it again? Will you turn from the Truth again?

Universal Brotherhood and its mutual interdependence through rhythmic balanced interchange must come into being in order to stop the fast-approaching wholesale slaughter of man by his own brothers. The day has come when it is quite possible that man may not only annihilate his own species suddenly by all-out atomic war, but more slowly through fall-out radiation and horrible mutations.

Not only is this possible but its forecast by that frightful word ARMAGEDDON is becoming more and more familiarly heard and written about than one would surely like it to be.

Nevertheless, men continue to deal with each other in an unbalanced manner which continues the process of disintegration, caring only for what comforts and luxuries the upper stratas can still get and with little thought or care for the lower underprivileged stratas.

Let us search for the reason of man's vast ignorance of the knowledge he has to learn. Study the dark nothingness of Fig. 59. **It is very difficult for the unimaginative observer to understand that there is no darkness anywhere except through its own limitations of outer vision.** That is why this early stage of man's unfolding needs new **inner knowledge**--to transform him into a Cosmic Being instead of a limited-sense thinker, and that is what we and other enlightened souls of today are giving to the world in order that man may find happiness such as the ecstasy of God's thinking.

We now print a series of diagrams to more vividly stamp this knowledge on man's memories.

Figs. 61, 62, 63, 64 and 65 will help visualize the principle of creating visible light into pictures of God's imaginings better than words could possibly do. **Man's peaceful progress depends upon the understanding and practice of these inviolate Natural Laws which govern his universe, whether he is aware of them or not.**

The one thing which is almost impossible for the mind of man to comprehend is to look into that blank dark nothingness of such a diagram as Fig. 59, and Fig. 63 in a lesser degree, and realize that **they are on three-dimensional angles of ninety degrees from their axes of rotation, like the eight other cubes and six tetrahedrons which govern that division by dividing the indivisible "nothingness" into divided pairs of spectrum lights for the purpose of again uniting them into the oneness from which they sprang.**

It will help to vision this opposition of direction by throwing a stone into the water. Even though the centripetal spiral which surrounds the falling stone is parallel to the

ripples caused by it, the direction of the force of its falling is ninety degrees from the direction in which it falls.

If these diagrams and the others throughout these lessons help to visualize the universe and the Creator of it into sufficient reality to help mankind to be transformed into Cosmic Knowers instead of "sensed" thinkers, our combined efforts in writing these lessons will have been well repaid. It is in this spirit that we will feel fully repaid and rejoice with you because of it.

I humbly thank you with all my heart for this opportunity today, in the sharing of this wondrous information by which you can turn your planet about from its destructive path. If you will stand with me, I will stand with you--and no person ever failed under my assistance! I speak now of your very Presence of Life as you move into wholeness. Suppose you have been trained in a particular activity: your Presence of Life, like a flash of lightning, can now prepare you and make you equal to whatever is required in your service that you desire. I want you to hold that unlimited action of your Presence through your own brain and body, because it is TRUTH.

In all the glorious things that are before you, be firm, be determined, and stand unyielding in your "Call" for the Perfection and limitless supply and all that you wish to have come forth into your use and action, through your body and into your world of action; and you have that eternal blessing, Freedom, and perfection of Life.

It is possible you still do not conceive what the power of Divine Love is in its fullness; but were you my children in a physical embodiment, I could not possibly love you one-tenth of what I love you today when I see your willingness to make the necessary application to be free. Knowing that we have by the identical, same application attained Our freedom, then do you understand why that Love is so great?

There is no human element in It, but a great power of love that wants you to have your Freedom because you are grown to the point wherein it is time to have these blessings which will lead you into that freedom.

I, Germain, wish to again share with you that a very Great Presence has recently come forth again from within the Great Silence. That Presence is giving you that assistance today, so I want you to realize that everything that the outer man is capable of receiving is being brought forth into action for your Freedom, sustaining power of protection, and supply. May you be given into the acceptance of that great Cosmic Light which is focused here upon you blessed ones, accept the fullness of Its invincible power, Its invincible protection, Its directing intelligence, and your freedom and victory in the Light now and forever sustained. I thank you.

I AM --- GERMAIN

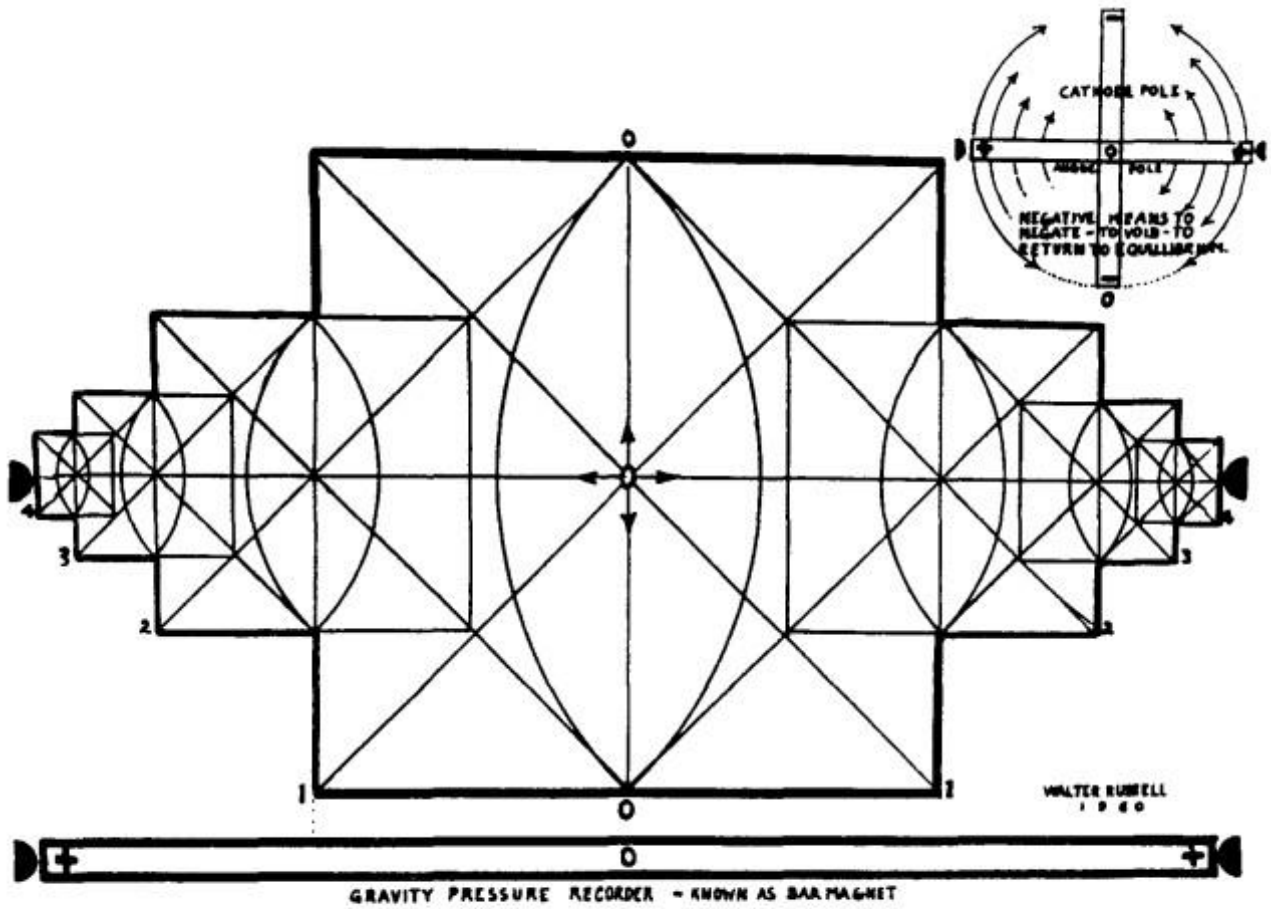

FIG. 58 This diagram represents the compression principle which is created by a series of biconvex lenses which are located on the wave axis at distances apart in inverse of the cube in volume and the square of the distance in length. Always visualize this compression principle when you think of the wave.

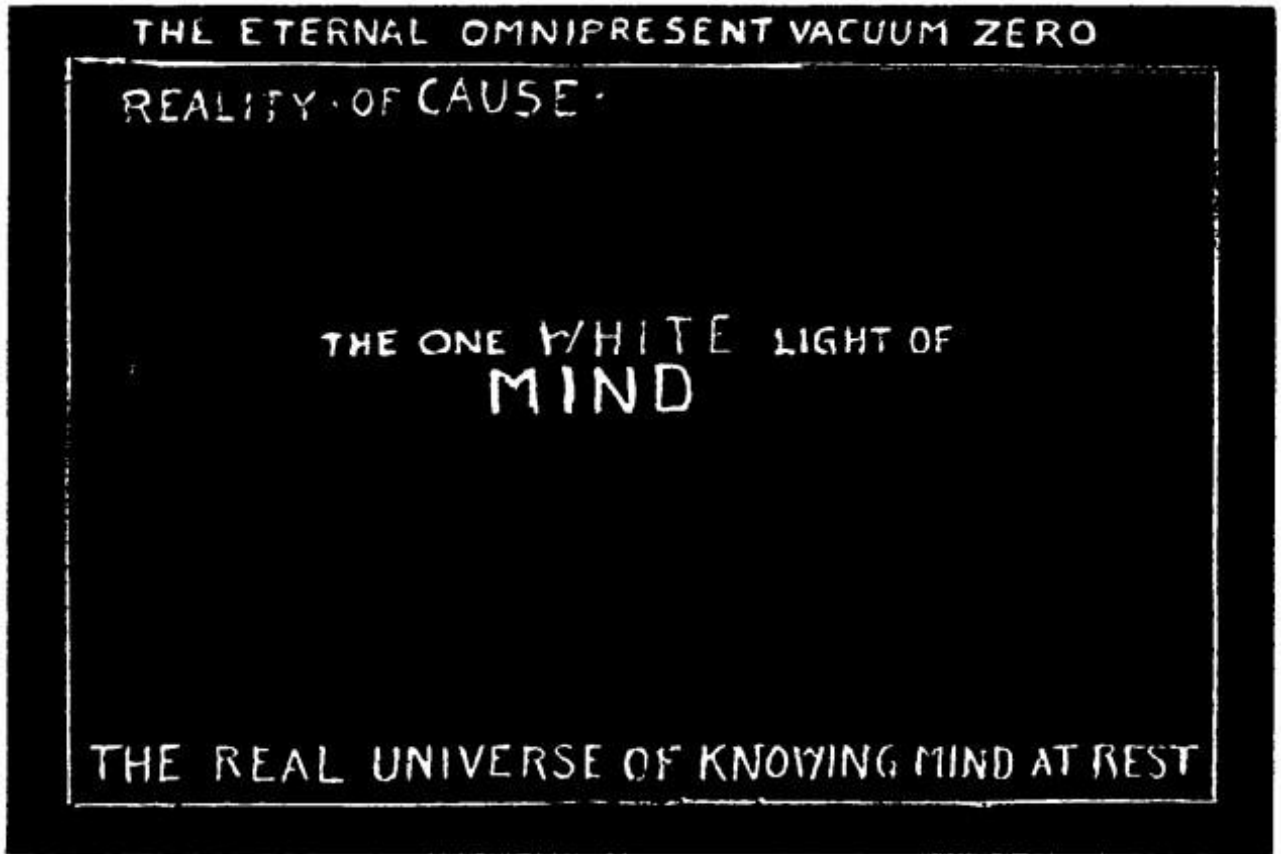

FIG. 59

The still universe of cold.

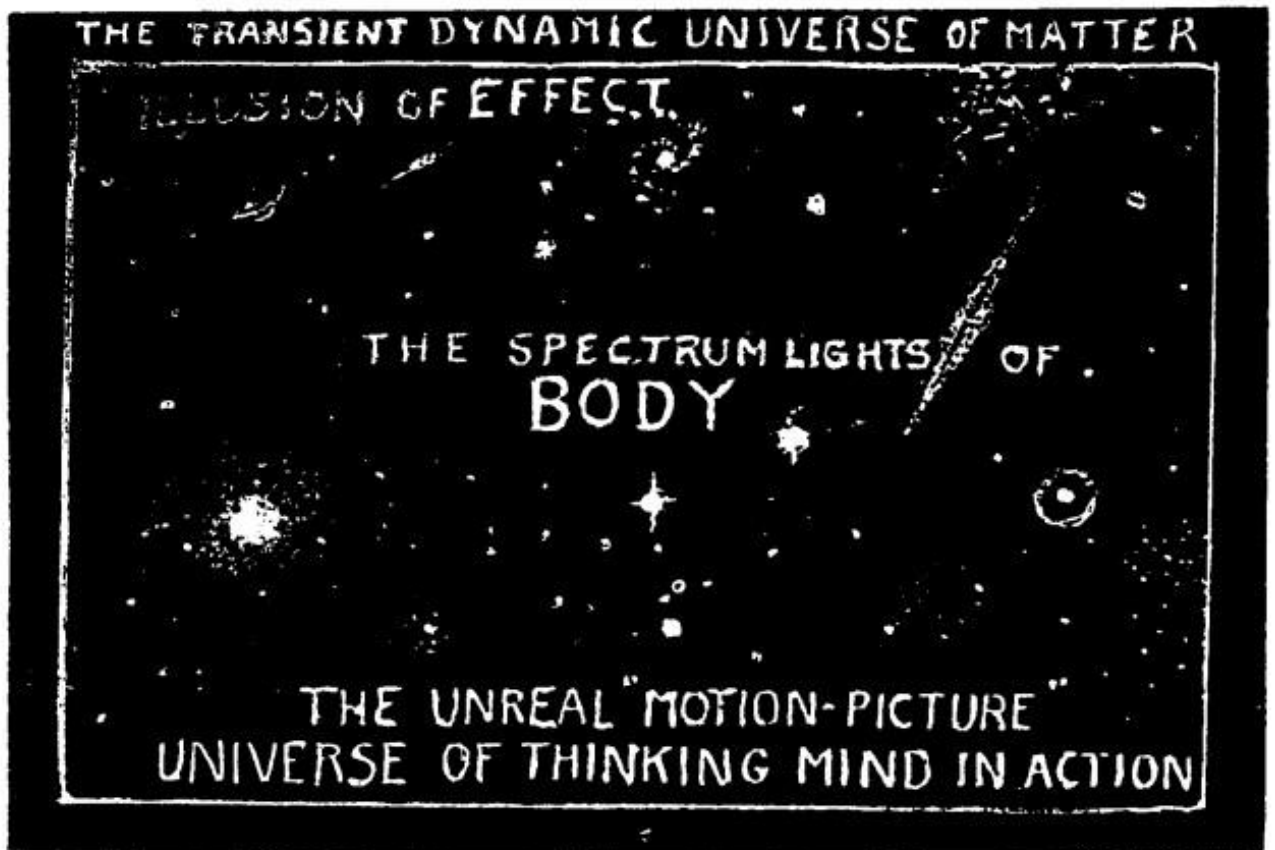

FIG. 60

The hot universe of light and motion.

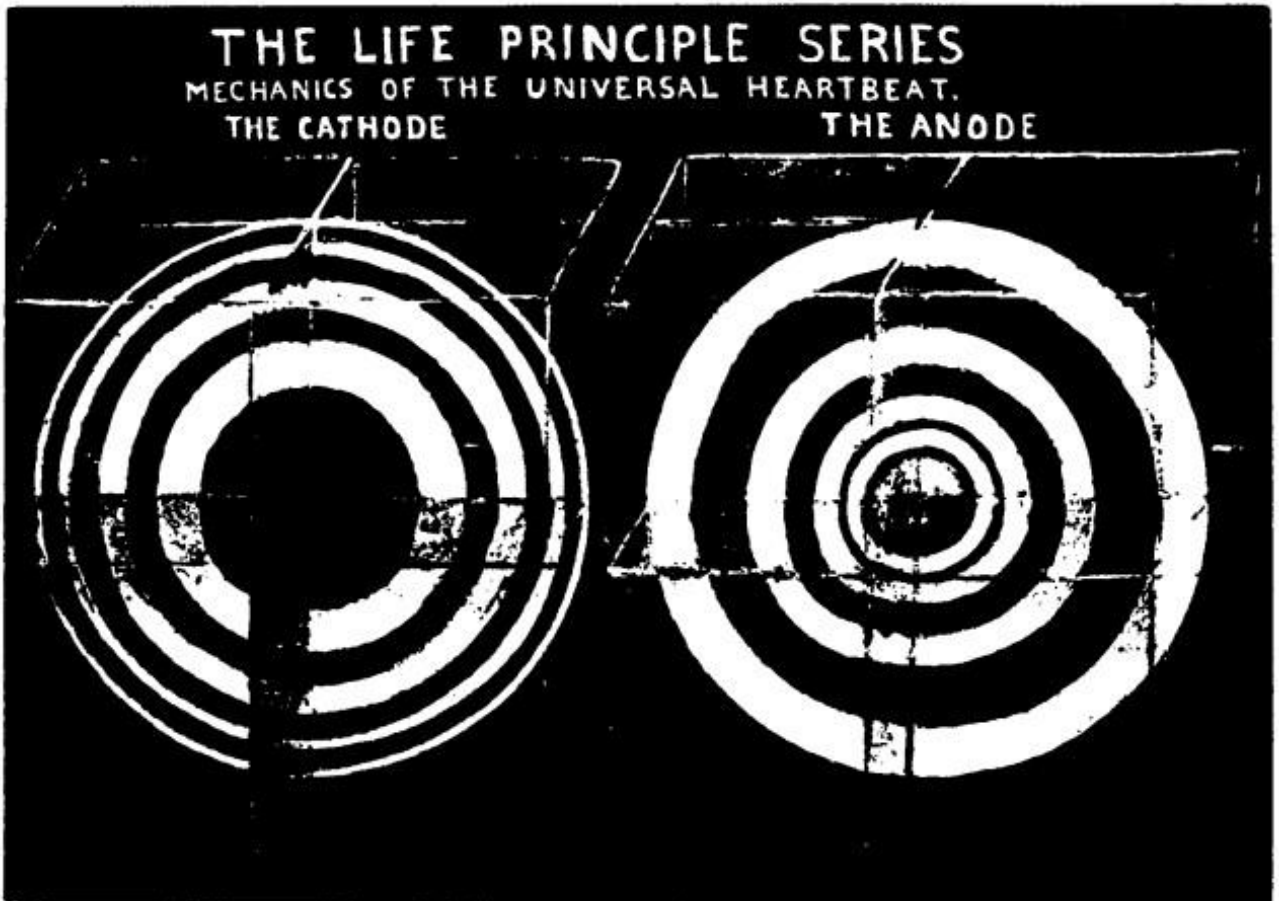

FIG. 61. The life and death cycle, as shown by the compression (cathode) and expansion (anode) rings enclosed in cubes of gravity control.

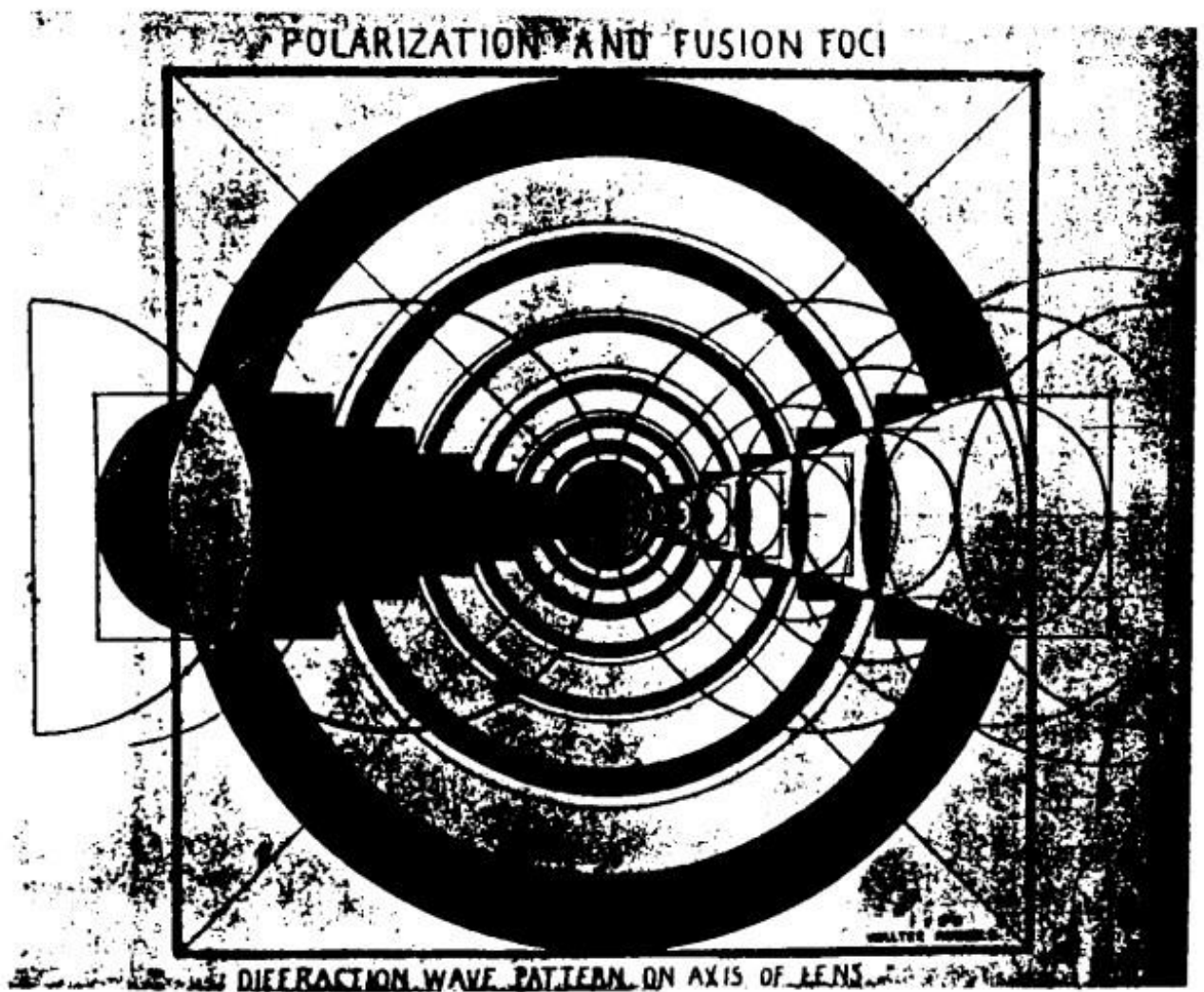

FIG. 62

The law which governs width of black spaces between diffraction rings, a law which has never before been known.

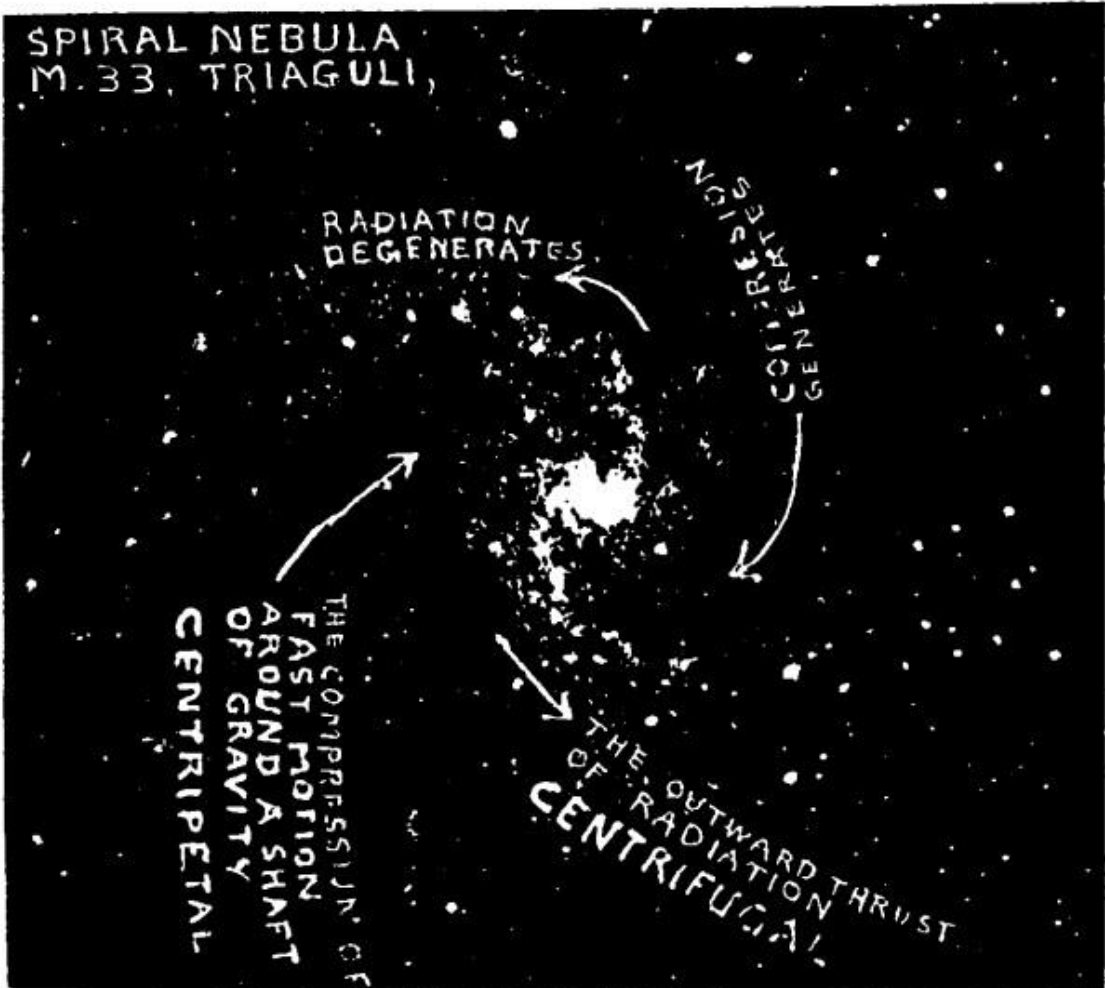
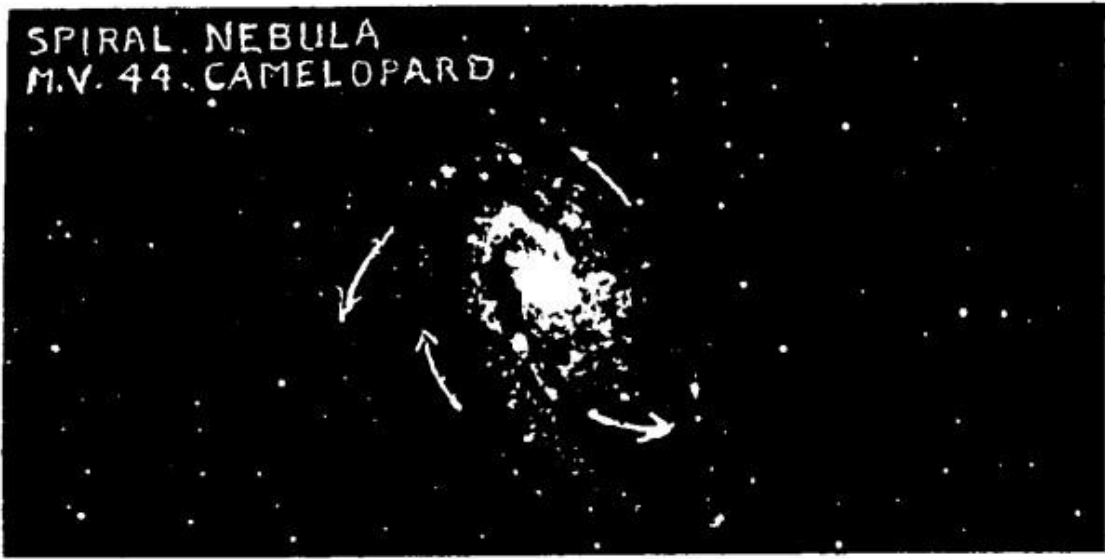

FIG. 63 The arrows on this two-dimensional flat surface seem to be also on flat surfaces. It is almost impossible to visualize that they are at angles of ninety degrees from their axis of rotation.

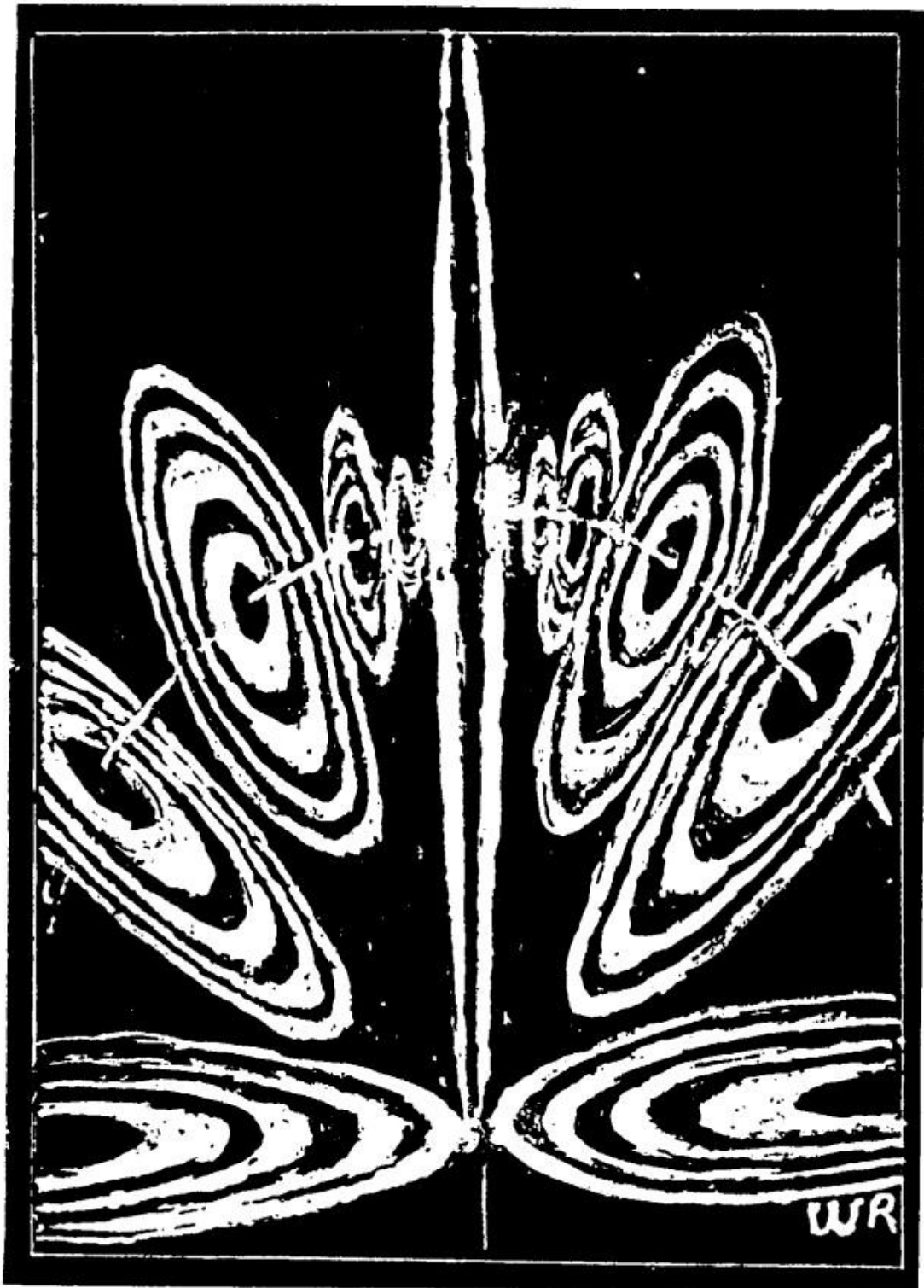

FIG. 64 Compression rings on the wave in octave formation, which is the basic cause of this curved universe of motion. In the center of this diagram are the expansion rings and spiral arms which radiate the heat which the cold has generated. (See our new Laws of Thermodynamics)

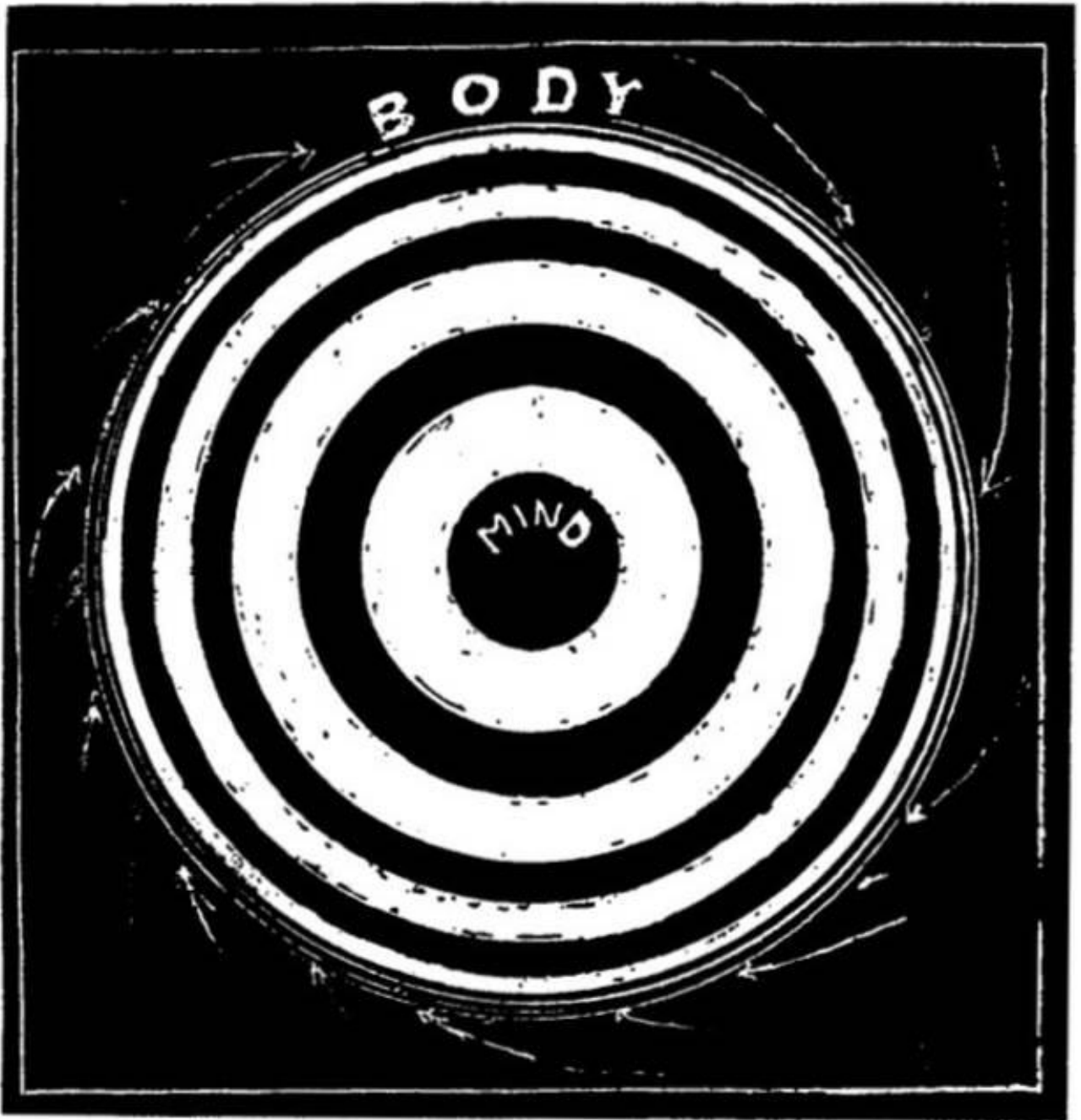

FIG. 65

This illustrates the light-wave current which runs through a solenoid of wire which helps this curved universe to be realized as such.

CHAPTER 10

REC #1 GERMAIN

SUNDAY, SEPTEMBER 1, 1991 8:17 A.M. YEAR 5, DAY 016

SUNDAY, SEPTEMBER 1, 1991

* * * * *

PERSONAL, DHARMA:

Would I not sit with you? Have I taught you so little, chela, that you think I will not sit with you? All you need do is ask. I AM, AND I AM AS CLOSE AS YOUR BREATH WITHIN--I AM ATON/HATONN AND YOU ARE MY HANDS.

Precious, the "conspiracy" is to pull man down into the depths of soul destruction--starting with the weak and innocent. These things of today are but the "sins of the fathers and mothers" resting heavily upon the heads of the children--but the parents realized it not, in time to prevent its coming. They, too, were brainscrambled in the path of the worldly physical expression.

The point, ultimately, is to pull all the children into social slavery and dispose of ones who are troublemakers. Man has no concept of that which is truly LOVE; he has been given the "happily ever after" lie until no relationship is now based on caring and friendship FIRST. Everything has become reversed in the order of application of life truths and in EVERY case the mind must be unlocked before the freedom can be gained. If not you--who? Dharma, words are nothing if not put into action--they are a bunch of scrambled alphabet pieces--nothing more.

If you can but consider the "problems" which cut through your own life in the midst of living WITH GOD AT YOUR HAND EVERY MOMENT OF EVERY DAY--LITERALLY--AS THE GIFTS THEY ARE, YOU SHALL SEE THE WONDROUS OPPORTUNITIES FOR REGIVING UNTO THINE BROTHERS THE SECRETS OF THE SOLUTIONS--WITHIN THE FOLD. Why you? Again--if not you--WHO?

We are giving man the outlay of heinous confrontations and now we begin to give the answers for the turning about and healing. God never gives only the tale of that which is wrong--HE ALWAYS GIVES THE WAY. Let us take that which is available within our family and bring it into unity and yes, precious, I will take the helm that you not feel the load. There will be no "miracles" although you will believe them to be such--but we shall develop a new road with open sharing, support and loving giving. I will not leave you to do anything ALONE. So be it. Blessings, for the next step is at hand--let us take it without the tarrying for a planet awaits.

* * * * *

INTO SPACE THROUGH OPEN DOORS:

THE ROAD MAP

Germain present to continue in the wondrous unfolding. Blessed are you who see and hear for through you shall be the Kingdom.

Once more the time has come when it becomes imperative that we have a new look upon our universe and totally discard all old concepts. Since science began, it has periodically erased old concepts and replaced them with new ones. Copernicus erased Ptolemy and Galileo erased Copernicus. Then Faraday and Newton and Rutherford, together with Bohr, erased all of them. Science today will never know its own tragedy and what it is doing to disintegrate mankind unless it erases all old concepts and substitutes the TRUTH of Nature's workings.

Up to the year 1926 the door had been partly opened by Mendeleef, who gave the world a chart of the elements perceivable by the eye as visible light, assisted by instruments which enlarged their scope to include hydrogen at the beginning and uranium at the end.

This chart was an impossibility in Nature for without seed, nothing can grow. **The inert gases are the seeds from which elements grow, just as plants likewise grow.** Mendeleef shows only five (Fig. 66) of the nine octaves which exist in Nature; we show all nine in our charts as we gave them to Walter Russell, and he charted them accurately for you. These are necessary to include the eight colors of the spectrum, or **four** pairs centered by "white". Do not confuse "octaves" with "groups".

We cite this because man is able to comprehend the fact that growing things also grow seeds upon them, which seeds form the basis for reproduction. Man is also familiar with the fact that separate species can be bred from a parent species in which identities are reborn from what they were before. This is a wonderful example of the unchangeability of the seed, even through death. The seed seemingly dies in the ground, but witness the weeds in your garden. Even though they are uprooted, they will return again and again. The understanding of this will help you in knowing why one octave grows from another and that a destruction of any such offshoot will cause a reversion to its parent species. (Fig. 67)

We use this to remind you of the principle which underlies our statement that destruction of such an element as carbon returns it to helium, the inert seed gas of the carbon octave. We also stated that elements of higher octaves, such as tungsten, if "electrocuted" would also return to helium and not stop at xenon, which is its own seed. We give that as an explanation of the fact that man had not yet known of any previous inert gas seed. Helium is the first inert gas cited by the Mendeleef chart. He could not, therefore, know that it had passed beyond helium because he did not know that lower inert gases existed.

The Walter Russell charts of 1926, which have revealed the existence of nine inert gases, and the much improved and more complete charts printed herein will help you better comprehend WHY every element of the entire octave will return all the way to the seed of its beginning in the still white Light of the Source of all of them.

These charts help us teach you the basic facts of life and instill within you the knowledge that the only way to accumulate power is by giving love out from your Self to other Selves and to growing things. To give love to another who sorely needs it is to give **him** power to conquer his needs and, in turn, it gives **you** power to give more from your Self. In that way, both you and he multiply the power to give more love out from yourselves.

Let us demonstrate that basic fact in plant life. Every branch which extends from a tree constantly needs more of the power of love to help it extend, and the giving of that power by its trunk gives more power to the body, even to its very roots. Likewise, each smaller branch which extends from that body gains and regives the power of love to the very roots. And that includes the smallest twig of another species which may be grafted upon it, and which is another identity, for that especially needs power to help it survive from the hurt of its "operation". Observe the work of Luther Burbank in transmuting trees by adding to their identity and thus making another identity, or that of the Negro naturalist, George Washington Carver, who transmuted the identity known as the peanut into two identities, the peanut and peanut oil.

This necessarily long prelude more fully prepares you for understanding how the desire for gaining power through knowing the secrets of God's Creation was gradually multiplied from the inconceivable "thinness" of the early octaves until their "thickness" made it possible for man to see and measure their body and potential. We talk about the vast distances of galaxies which are millions of light years away, but even a super intellect must strain to comprehend such distances as that. The distances in the early octaves outside of our own centering ONE are almost beyond imagination. It is, therefore, incredibly strange that man IS large enough in intellect to have cumulated enough of the power of knowledge to make use of it in his science in controlling the little he knows to make implements such as his early stone hatchet and, in later years, his telegraph, radio, radar, airplane and astronauts' satellites.

We now, therefore, print the two charts of the elements made by Walter Russell in 1926. Figures 68 and 69 show how it is that atomic energy came into man's world. The recent and more comprehensible chart, Fig. 70, affords still greater opportunity to show you how extended elements of matter must return to their first octave gas for renewed power, even as the extended branches of a tree reach to the very roots of it for continuous renewal of their power.

These will then help you understand the transmutation principle, the power projection principle and the solar energy principle which will aid man in

advancing his science a thousand years in the next short decade and thus realize his purpose of manifesting the God of Love upon the earth.

I climax these lessons with the new knowledge of how man can multiply his power only by giving out from himself to other selves.

Let us study Fig.70 with this idea in view. First take note that carbon is the **pivotal center** of the nine octaves and is in the anode position. It is the first of the wave amplitudes to have closed its hole and reversed its direction of compression from outward to inward. Its balanced position makes it possible to be encircled with the true matehood of geometric symmetry.

Table of the Periodic Law. (Mendeleef, 1904.)

Atomic Weight	Group I	Group II	Group III	Group IV	Group V	Group VI	Group VII	Group VIII
1	H 1-1							
2	Li 7-3	Be 9-4						
3	Na 23-1	Mg 24-2	B 11-3	C 12-4	N 14-5	O 16-6	F 19-7	
4	K 39-1	Ca 40-2	Al 27-3	Si 28-4	P 31-5	S 32-6	Cl 35.5-7	
5	Rb 85.5-1	Strontium 87.6-2	Scandium 44.9-3	Ti 78.9-4	V 50.9-5	Cr 52-6	Mn 54.9-7	Group VIII Fe 55.8-8 Co 58.9-9 Ni 58.7-10
6	Cs 132.9-1	Ba 137.3-2	Yttrium 88.9-3	Zr 91.2-4	Nb 92.9-5	Mo 95.9-6	Tc 98-7	Ru 101.1-8 Rh 101.1-9 Pd 106.3-10
7	Rf 186.2-1	Ra 226-2	La 138.9-3	Hf 178.5-4	Ta 182-5	W 183.8-6	Re 186.2-7	Pt 195.1-8 Au 197-9 Hg 200.6-10
8	Ac 227-1							
9								
10								
11								
12								

FIG. 66 The Mendeleef chart of the elements.

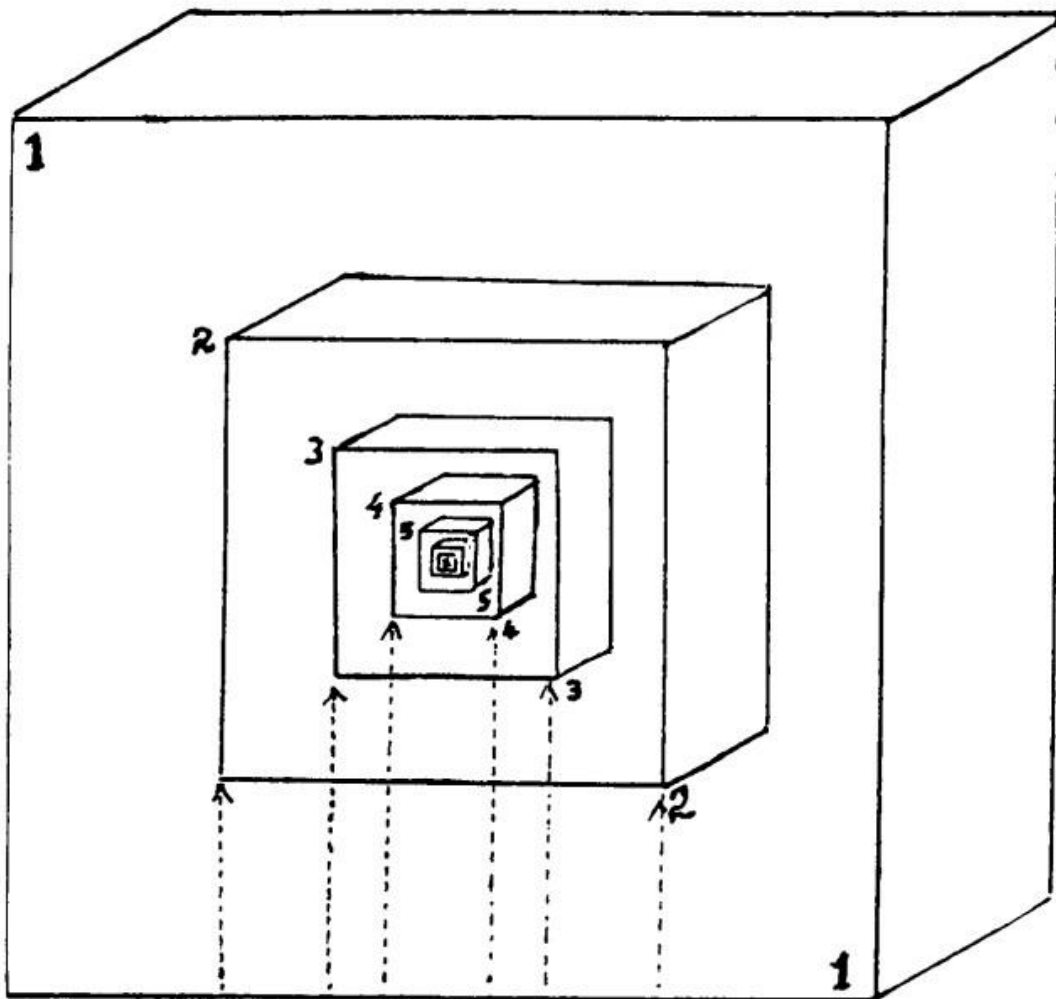

FIG. 67 The nine octaves of white light accumulating in the ratio of the inverse cube, of which the centering cube contains within it our nine-octave universe from invisible light to visible, and even then not visible until its fourth octave.

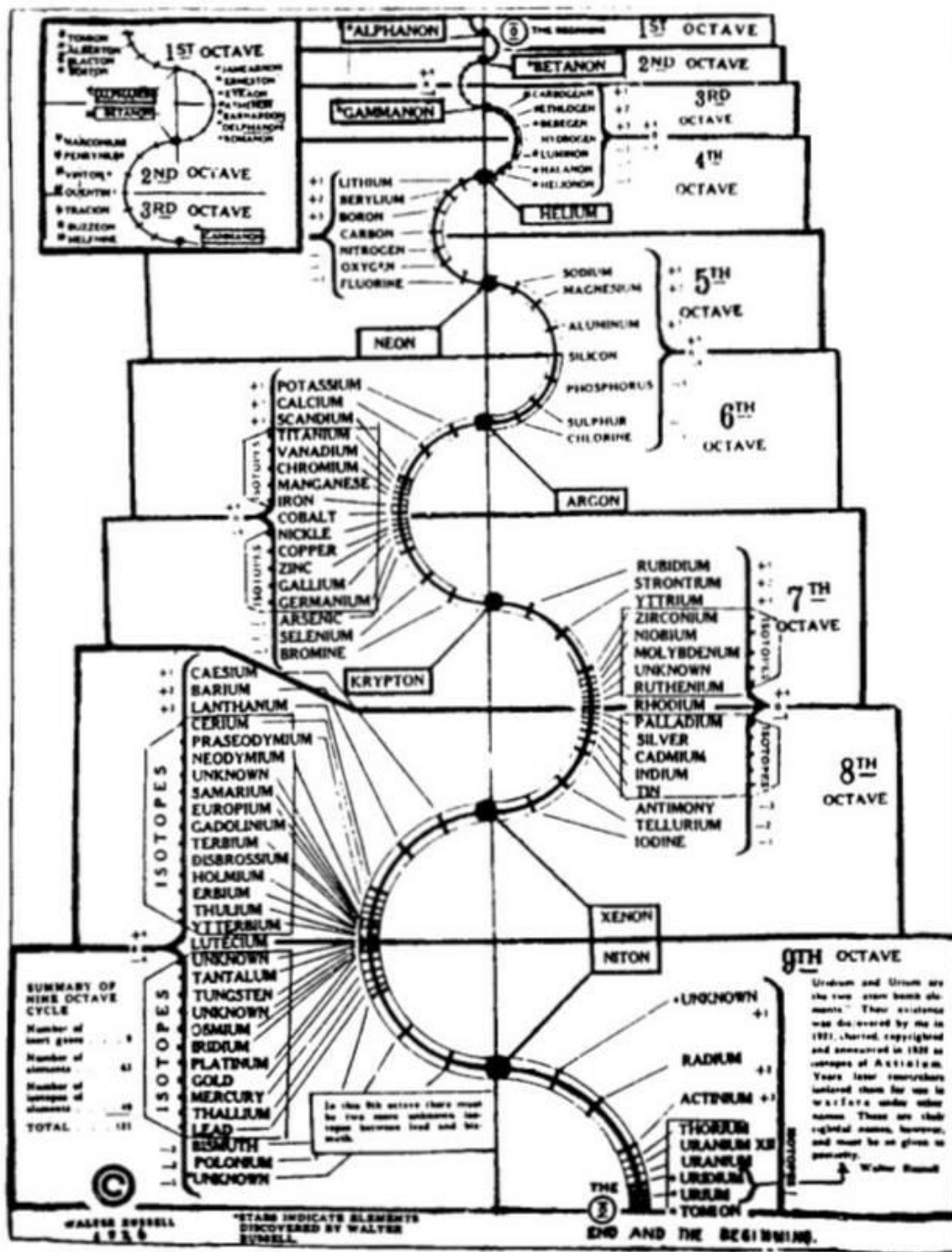
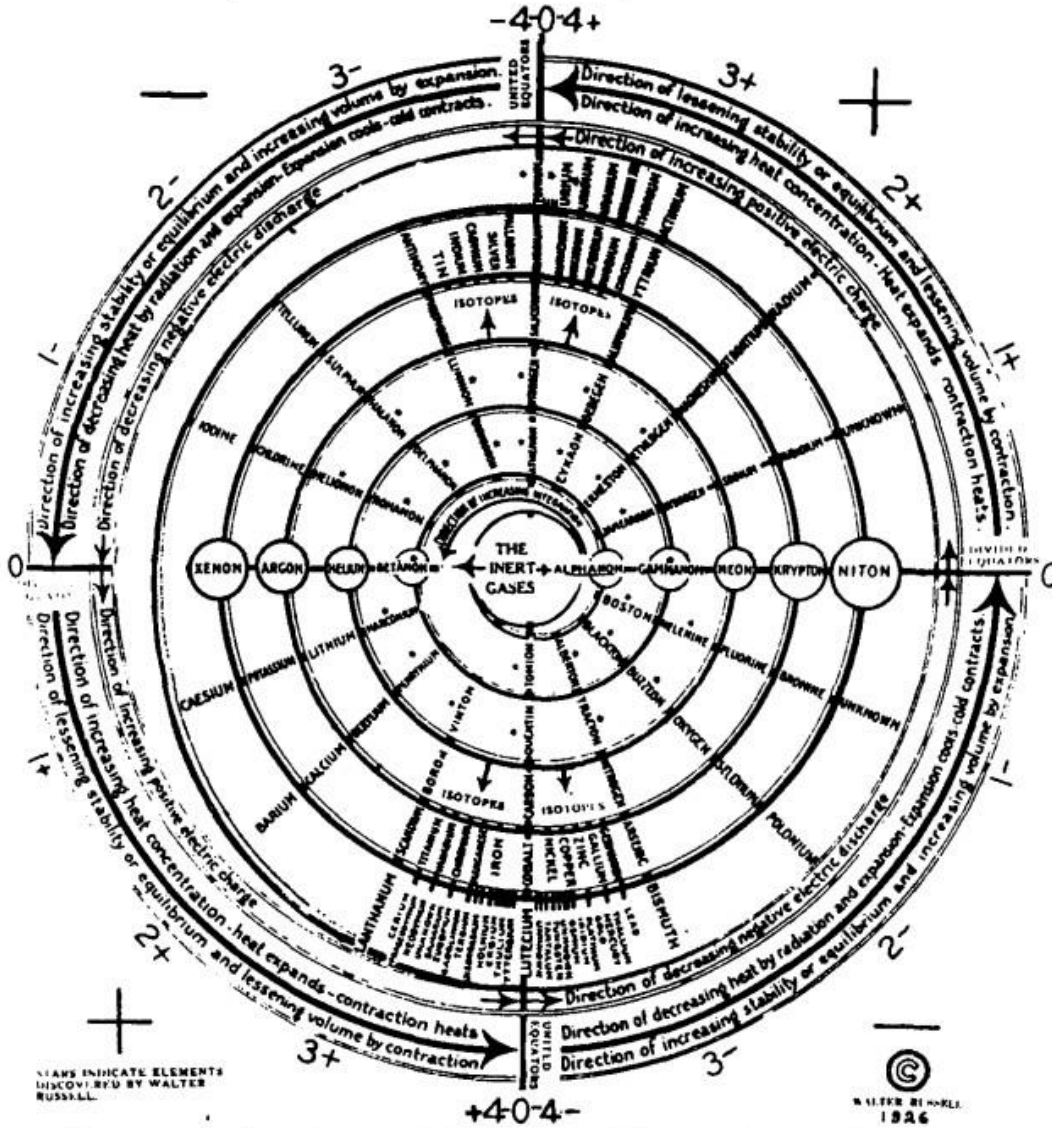

FIG. 68 The Russell Periodic Chart of the Elements, No. 1

One of the two completed Mendeleef tables of the elements which Walter Russell gave to the world of science in 1926.

Periodicity is a characteristic of all phenomena of nature



STARS INDICATE ELEMENTS DISCOVERED BY WALTER RUSSELL

WALTER RUSSELL 1926

The nine octaves of the elements of matter manifest the polarization principle for producing dynamic action by extending two equators from a fulcrum point of rest. These two equators arise by gyroscopic action, multiplied centripetally, in four concentrative efforts to an amplitude plane which is 90 degrees from the zero plane of the inert gases. They then descend in four decenterative, depolarizing stages to disappear in their inert gases and again reappear from them in endless cycles throughout eternity. Thus do all bodies appear and disappear — to again reappear — forever.

FIG. 69 The Russell Periodic Chart of the Elements, No. 2

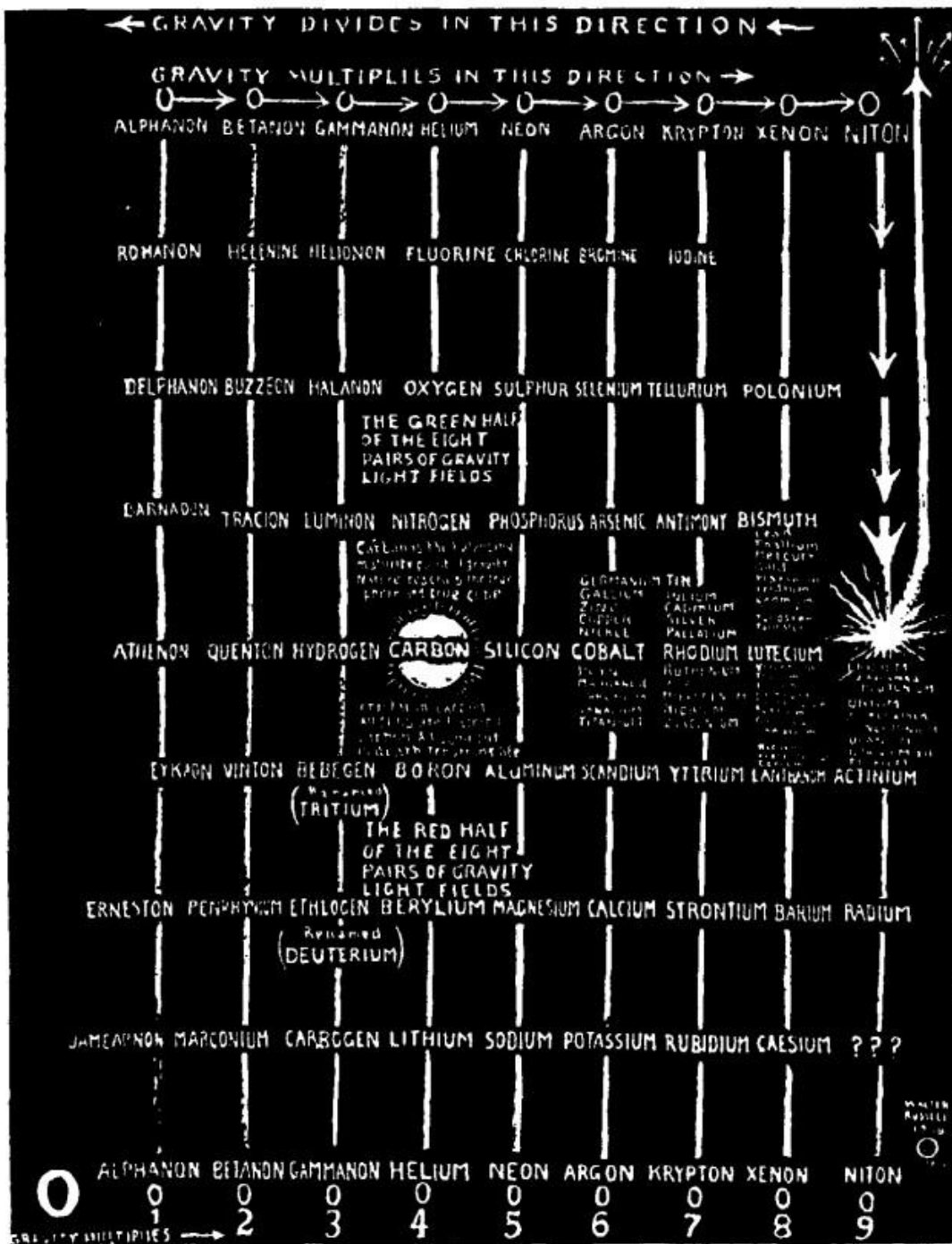

FIG. 70 THE WALTER RUSSELL CHART OF THE ELEMENTS OF MATTER
(The 1960 comprehensive chart)

The succeeding amplitude positions lose that simplicity. Silicon, the next one on its wave amplitude, complexes to hexagonal symmetry. Then come cobalt, rhodium and lutetium which still further complex until the plutonium-neptunium ninth octave makes any form of crystal formation impossible by the multiplication of heat so that the entire octave explodes and gives back to its very roots all that which was given to it. But, like the tree which burned or died when it had matured, another tree or group of trees will sprout from those very roots.

Carbon is the first amplitude element which has acquired sufficient strength to extend "children" from itself. Its completed spectrum, divided by a uniting equator, places it in the father-mother position, both of whom as divided pairs have united in balance to produce children such as our Earth, Mercury, Venus, Mars, Saturn and the outer planets. All of these planets and their moons are children of our sun. It has been but a few hundred million years since human life became existent on our earth. Venus will be the next planet to become ready for human life like this earth. However, it will not be ready for such life for several hundred million years. It takes all these long years for preparation to reborn the seed of humans like you in places rebirthed and reclaimed. Your earth will slowly pass out into the cold of space as Mars, Saturn and the outer planets have already done. It is fine--for it is the cycle of rebirthing and reclamation and then new suns can be borned for it is the never ending story of God thought and manifested experience.

When Venus is finally ready for life, the human seed will appear on it because the seed is carried in the inert gases and it is **ETERNAL**. No better example could there be of the indestructibility of **IDENTITIES**. This is the very basis of transmutation that we will show you when we come to that subject.

The lesson to be learned from this principle is to attain such a character as to be assured of one's **ONENESS** with God.

When cobalt is reached, it has gained more power and can produce other elements which return at maturity to their alpha roots. Rhodium and Lutecium have extended more such "branches" from their bodies and these have strengthened the main trunk, carbon, so that it can extend even stronger branches until the trunk can bear no more and the strength to support them breaks down from the very strain of it and explodes the whole nine octaves back into the very fires whose heat rays gave them birth.

Note that the speed of light has not developed in any of the other eight octaves preceding your ninth one to produce incandescence in them, and not then until carbon has at long last filled its hole. Density then increases from the outside in. Heat also increases from the outside in. Not even in hydrogen, the amplitude element of the third octave, is there incandescence of itself. We have to make it so by adding incandescence to it in the form of fire.

If that were not so, the immense bulk of hydrogen in outer space would explode the whole universe. That tells the story of the smallness of our visible universe, which is only five octaves of the entire nine, and the inconceivable time consumed in making the Creator's thinking in light become solid enough to create formed bodies.

POWER PROJECTION

We now apply our knowledge to complete control of gravity power. As we promised in our previous lessons, we will first consider the mystery of power projection. By that we do not mean power to project missiles from a point in this country to some other point in other countries beyond the Atlantic. **We mean power to destroy missiles in those other countries, or anywhere underseas, by destroying the very metals themselves within which their explosive material is encased. Isn't this fun? In other words, the enclosing metals can be so intensively heated and their conductive and inductive qualities so vastly multiplied that the explosive material within them will ignite and burst their casings.**

The secret of that is the same as makes transmutation possible by being able to compute the pressures of the elements. You will remember from past lessons when speaking of the language of light, we stated that its basis lies in the fact that **every created thing manifests only the idea of itself and cannot be a part of the identity of any other idea.** Fig. No. 70 makes that meaning comprehensible. **It is all based upon the fact that the pressures developed in any element have their own distinct, unchangeable identities which are measurable.**

A single simple example of that meaning is the thermometer. The identity of the man-idea has a distinct pressure of 98.6. The exactness which is so finely calculated down to a minute fraction indicates the knowledge of control that science has, to be able to compute it. If a human's temperature is even one point higher, we know that he is ill. If it increases to 1 or 2 points above 103 degrees F., you know that it would be impossible for him to survive unless he could conquer it and do so rather quickly.

This being known, it is mathematically possible for science to measure pressures of every element in the entire octave series with computers and other finely attuned instruments and establish unchangeable identities in any element so that power projected to them would, as we stated before, destroy their like identities even in far-off countries. Distance has no meaning whatsoever.

It is needless to repeat what we have so often stated about the multiplication in octave progression in electronics, so we will now proceed to the discussion of transmutation.

By the way, you would-be scientists: KNOW THAT WHAT YOU SEE IS WHAT YOU GET--ONES HOLD KEYS AND I WILL NOT JEOPARDIZE THIS SCRIBE BY COMPREHENSIVELY ANSWERING A MYRIAD OF QUESTIONS FROM YOU ONES WANTING THE RECIPE SPELLED OUT FOR YOU. MANY ARE THE ONES WHO KNOW EXACTLY OF THAT WHICH I GIVE HEREIN AND IT

MUST BE GIVEN IN SECURITY. The time of bringing this forth into public hands is at hand but the time of being allowed to utilize the information for full, worldwide use is not yet at hand--for first, you must acquire control of your world in the name of God and within the "LAWS". You get YOUR job done in that respect--and the rest will follow. A lot of this transmutation and "invention" has been accomplished--many of Tesla's private papers, which were taken by the government at his death and at various "raids", outlined these things. Fortunately for mankind--the teaching through the usual university standards so trained man into the lie that much lies safely awaiting the touch of God-ness.

TRANSMUTATION

Transmutation is based on the fact of gravity control of light. All light is curved and there are no parallel rays in it, as shown by the textbooks on optics. If you look at the diverging rays of light which are projected from the sun, they appear to be straight but even they curve from sun to sun in long and short curves as they progressively curve SPIRALLY toward the focal center of all suns throughout the universe.

There is, however, a straight line at the equators of curved ones, but even they move spirally around an orbit of their final focal SOURCE in GOD, their Creator.

This definitely proves that all Nature, which God's thinking is, must move around THE THINKER in equally divided thought-wave pulsations which forever spiral centripetally to create illusions of time and continuity of motion in a still universe in which there is no motion.

All of these facts about the nature of light in a curved universe must be considered by those who attempt to transform matter from one element to another. Its difficulties are not so complex, however, if these basic facts are understood. The du Pont Company proved these principles when it found new atoms by exposing them to light pressure but they did not know what they were. **That is because they did not compute them mathematically to find the exact pressures necessary for pure known atoms. They, therefore, produced "mongrel" atoms of untraceable mixtures.**

A scientist, or group of scientists, of the Central Scientific Company, of Chicago, has given a great advancement to science through the magnification of the atom some 2,700,000 times, thereby bringing it within range of the eye to see. (Fig. 71) The instrument is called the Cenco-Muller Field Ion Microscope--the element, tungsten. This makes it possible to look directly at God and thereby prove that there is naught but LIGHT in all the universe. That Light, which God is, is invisible and inert when cold. It becomes visible only when being compressed by motion--in other more simplistic terms--God in action!

This discovery makes it possible for all electronic workers in the field of computers to be more exact and for radar engineers to vastly improve their instruments. It will also

greatly aid science in the field of transmutation. You see, you ones wish to stick with Priore and Rife when the advancement is so much beyond those simple microscopes and frequency boxes. These ones made great leaps and bounds into science but they did not find the "TRUTH" of it and therefore the "boxes" cannot work to perfection but only through the centering KNOWING WITHIN MIND OF CAPABILITY. Yes, they served and served well and were onto the correct assumptions, however, let it be known that what happens that viruses are killed in the electron microscopes is due to the principle laid forth above. Viruses are but crystalline substance and therefore if one portion of the whole is changed (too much fever) you have changed the entity--not necessarily "killed" it. THERE IS NO SUCH THING AS DEATH--REMEMBER?

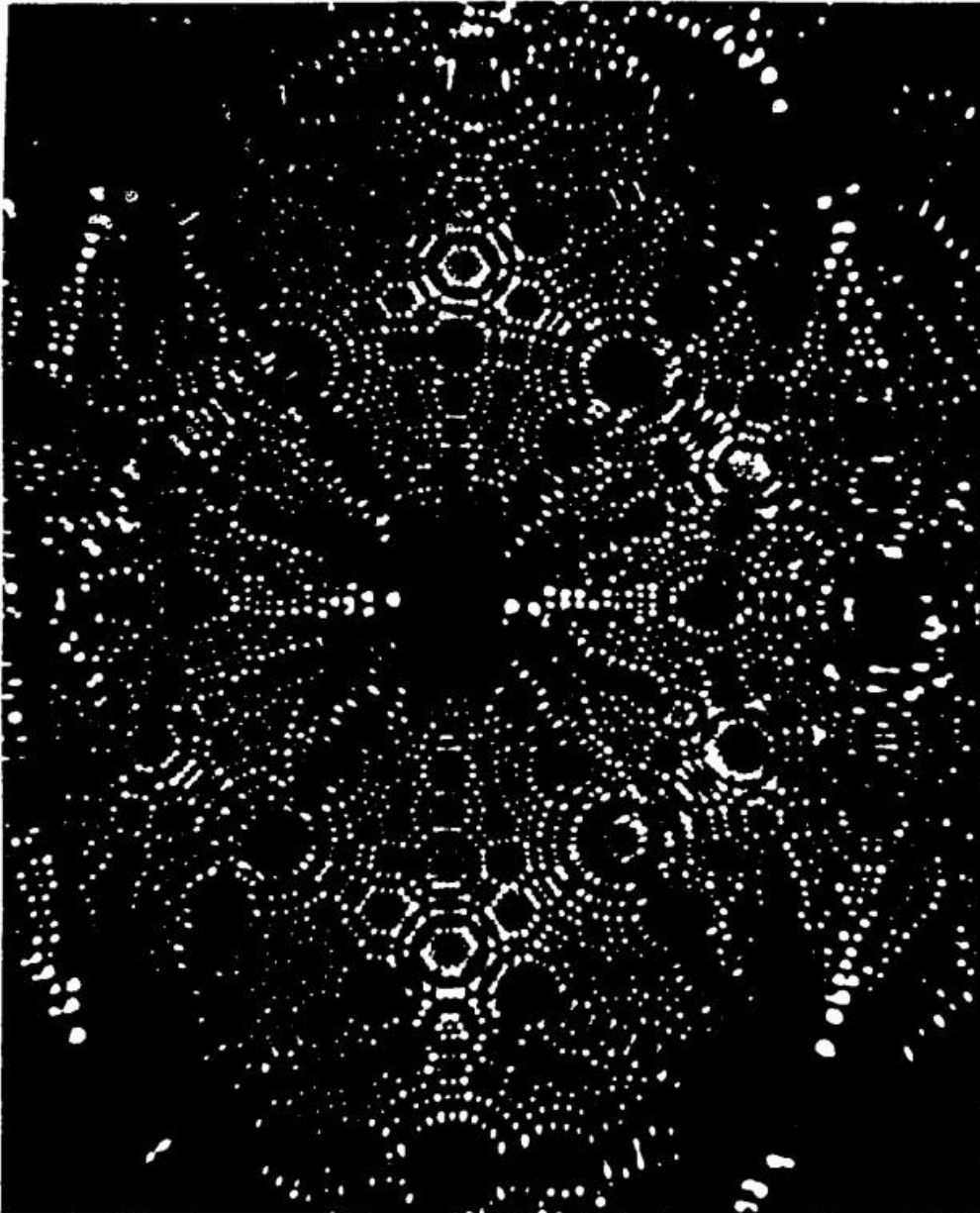

FIG. 71 Photomicrograph of a pure tungsten crystal magnified 2,700,000 times, which was made by the Cenco-Muller Field Ion Microscope. The hexagonal form of water crystals is clearly shown in this picture.

THIS KNOWLEDGE IS OF INCALCULABLE VALUE IN PROVING THE DIVISION OF THE SPECTRUM AND THEREBY THE EQUALITY OF ALL PAIRS OF OPPOSITES AND THE STATEMENT WE HAVE CONTINUALLY MADE THAT FIRE AND WATER ARE THE ONLY PRODUCTS OF CREATION, FOR FLAME BECOMES VISIBLE WHEN COMPRESSED AND INVISIBLE WHEN EXPANDED INTO COLD. BETWEEN THESE TWO EQUALLY INTERCHANGING LIGHTS OF REST AND MOTION LIES THE LIFE PRINCIPLE OF CREATION. These scientists are worthy of great recognition as are ones who have taken this even further--but these were the first really successful in their attempt.

Let us look more carefully at the photograph of the atom (Fig. 71). Study it with us:

1. Observe that the complete atom is hexagonal.
2. The outside hexagons are very large and all other hexagons become repeatedly smaller.
3. Observe that each atom, no matter how small, is surrounded by ripples which prove that they are water and, as we have stated before, **nothing other than water and fire were ever created. We also stated that fire destroyed everything that was ever created and returned it back to its original static cold zero for repetition.**
4. Let us further consider the incredibly and inconceivably small particle called the "atom" in the light of the seed. This means that the seed is a living thing for it begins to pulse. **All living things pulse**, which means that they are breathing in and out.
5. Pulsing seeds grow larger and larger. As they grow larger, they beget larger bodies of fathers and mothers.
6. It is an interesting fact of Nature that the father germ seed must be injected into the mother to produce pulsing life by motion.

All of the growth of the universe is finally returned by aeons of accumulated heat through the growth process of this curved universe, as outlined above, which repeats itself over and over again, for God will never cease to think.

If you will but meditate upon this subject long enough to completely comprehend it, you will have gone far into your own understanding of what inner vision or Cosmic thinking means. This will help you attain the power that inner vision gives you in the command of yourself and of matter--and you who are awaiting service in the field of new technology as utilized by Cosmic brothers--harken, for here is that which you await.

One more subject must be clarified in order that researchers are not misled by unnatural "discoveries". Science recently referred to the inert gases as "noble" gases because of the known fact that they would not mix with each other or with any other element. How could they? **They are the SEED of all the octaves of elements. One cannot mix seed but one can "mix" its extensions, just as two kinds of woods can be grafted together.**

The one simple thing that punctures their "discovery" is that they also announce that there are twenty-nine such "noble" gases. **There are nine inert gases only because there are but nine octaves, science being aware of only the five given in the Mendeleef chart, helium, neon, argon, krypton and zenon. Atomic energy would not be possible if the plutonium octave did not have niton as its seed from which to grow.**

Having disposed of these roadblocks, we will now proceed to the mechanical means for providing that needed power to compute the exact pressures necessary to produce definite identities.

Necessarily, these must be conical solenoids. If the exact number of turns of wire can be computed to give octaves the proper pressures which Nature gives them, they will heat at each 1 - 2 - 3 - 4 octave. Much experimentation may be required to make them so, but once they meet mathematical requirements they will then be standard and be repeated. **THEY MUST BE, FOR THE "LANGUAGE OF LIGHT" TELLS YOU THAT IDENTITIES CANNOT BE CHANGED WITHOUT MONGRELIZING THEM.** Instead of obtaining the pure gas or metal that one needs, the product is not quite the one its identity calls for.

The work of transmutation also will greatly aid the mathematician to calculate his pressures, which he must do before he can transmute one element into another. Transmutation is one of Nature's orderly lawful processes. It is continuous in its cycles of rotation.

You have seen this process carved in the falling meteorite which turns into flame while resisting the friction of the atmosphere and then into water again as it carves its own photograph into the frozen stone of which the meteorite is composed. You have seen oxygen and hydrogen turn into flame by the frozen stones of the meteorite's body in different parts of the world when they were dug up from the earth, stone literally being flame a few seconds before. You have seen volcanoes belch forth great flames of fire into a wet atmosphere which carved their photographs into lava, which frozen flame is. Why, therefore, should man have any trouble in finding out the secrets of transmutation when there are such discoveries to vastly aid him as knowledge of the inside of the atom magnified 2,700,000 or more, as recently given you?

Water is continuously returning to fire and that process is again repeated by fire turning to water. Even the astronaut, John Glenn, saw this happening in an orbit

of zero curvature where the atmosphere was presumed to be a void. In one moment he saw snow appear which turned to fire before his eyes and then the flame instantly disappeared and turned again to snow. We have mentioned this fact before but, as an example of the natural processes of Nature, it is worthwhile repeating.

As we have preciously stated, amazing help in making all calculations can come from the picture of the INSIDE of the atom (Fig. 71). Producing atomic energy is dangerous work. Atomic energy must flow its dangerous heat into a steam turbine while lenses can create energy from steam of superheated water. This can be done WITHOUT danger. An intense heat can be generated that would develop steam which could be led into a steam turbine for the creation of a dynamo or reactor as powerful as an atomic one but totally free of danger. The problem of heat must be solved in order that the coils do not overheat. The tubes which must run through the octave focal points to carry the transmuted material from atmosphere to gas or soft metals (dense ones being years away at this point) would not get their required heat. Liquid helium could then be used to enclose the cones and heated and pumped through them. A more simple and exact principle is the real solution of that trouble--**POWER FROM SOLAR ENERGY IS THAT SOLUTION**, so let us speak of it.

SOLAR ENERGY

Here it becomes imperative that the solar cells and photovoltaic modules (cells) be looked at in a different scope.

Long years of costly effort have been given to the solution of solar energy with very little results worthy of note. **The reason for that is because researchers have NOT used the octave progression principle which multiplies heat intensity.** Flame can be produced by holding a biconvex lens over a piece of paper or wood splinters, but that is not enough heat intensity. Vastly more heat can be obtained by using the octave series of lenses.

You require more heat than the sun and one series of lenses alone can give you. Two stumbling blocks to this principle are cloud obstruction and the dark of night. However, you can acquire without break the intensely hot and WHITE light of oxyacetylene flame. The sun is 90,000,000 miles away. By the time it reaches Mercury, its temperature has greatly reduced, and even more so at Venus whose surface heat is over 200 degrees while the earth's surface averages about 70 degrees. That is because the sun's white light has been filtered out and you receive only its red rays on your earth.

Let us then proceed upon the basis that you will use the WHITE LIGHT which you have multiplied and brought into visibility by short wave fast motion which you have multiplied from the CREATOR'S invisible, motionless Light upon which this universe is based.

The mechanics of this principle are also simple. Veritable Niagaras of power can be acquired from it. Let us diagram them to work without need of experiment to meet the requirements of exact identities of unchangeable elements which are strictly pure. We show you a diagram, Fig.72, which represents a metal frame around banks of lenses which project underneath in the octave multiplication systems given throughout all of the last of these lessons. This bank of octave lenses can be one of many series of such banks. If enough of them were assembled under one hot white light, a veritable Niagara of heat-power could be concentrated upon a pair of metal plates between which water can be pumped at one end and come out boiling at the other end. The boiling hot steam thus compressed can lead directly to a dynamo or reactor and the problem of solar energy has been solved for such needed purposes as purifying polluted river water or salted water of the ocean. Is everybody with me? This is why you would not choose oil, for instance--this gives reclamation for water great potential. This would also save piping sea water thousands of miles inland. Pure water can be also transmuted from the atmosphere as well as pure hydrogen and oxygen for fuels or to make rain. Much of this has been made operational and hidden from you-the-people and is now being used as terror tactics against you.

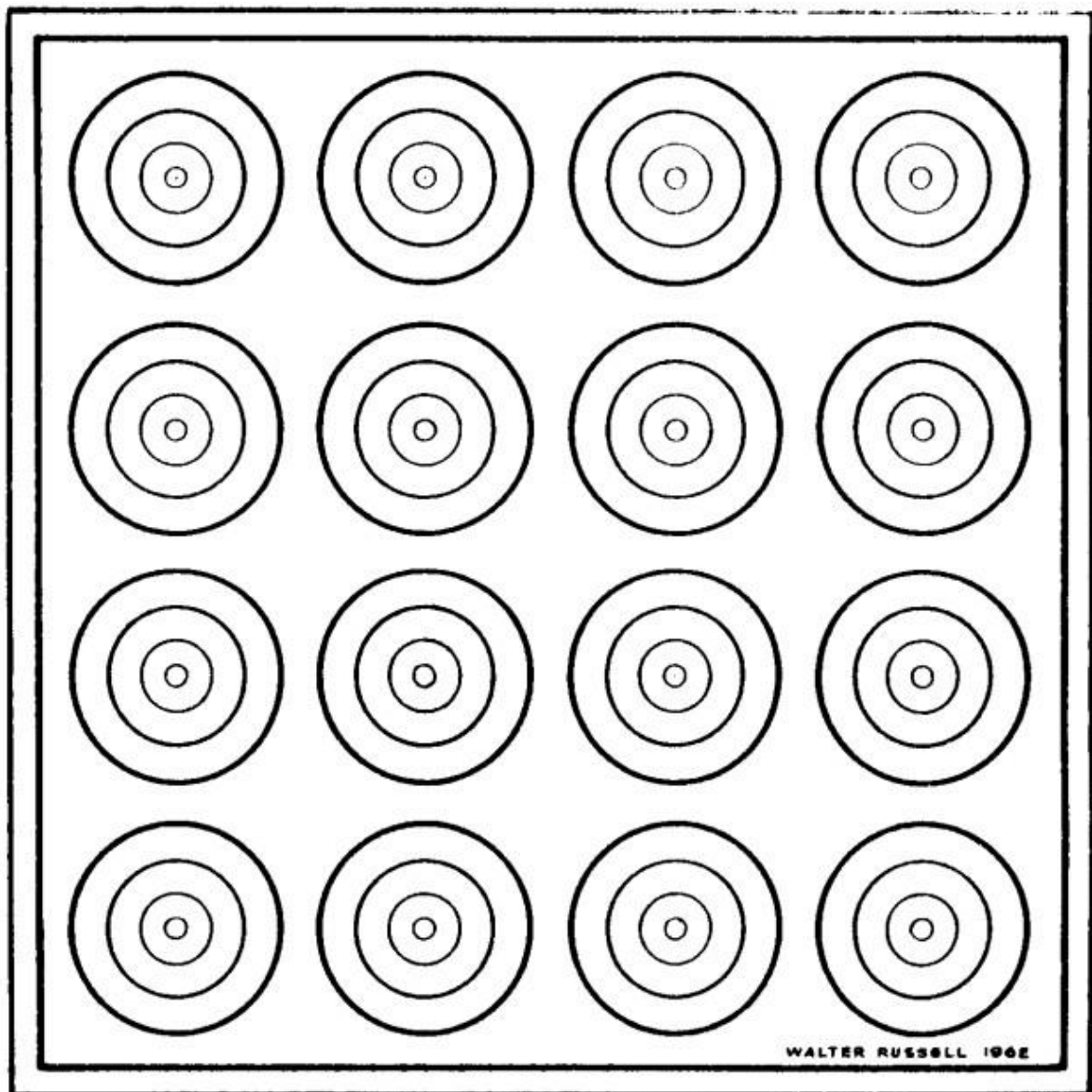
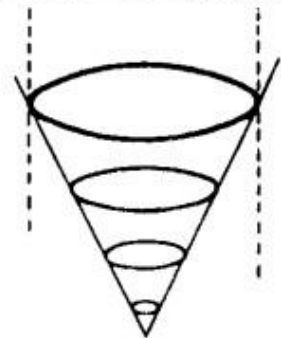

FIG. 72 One bank of an octave-multiplying assembly of lenses for solving the problem of solar energy, now given to the world in 1962 by Walter Russell. You are looking down through a 4-octave series of lenses such as you find on bar magnet drawing in Fig. 57. They represent the light which comes from the sun, but that light is diminished by the light of the sun having traveled through space for 90 million miles and its continuity having been interrupted by night and by intermittent clouds, for light does not shine in the darkness. Because of this discontinuity, transmutation by solar energy is quite impossible. A better light because of its whiteness and because of no interruptions by long periods of night and clouds is the oxyacetylene flame, as we have formerly stated.



As we have continually said, Natural Science is simple and uncomplicated since the Creator's ways and processes are simple and uncomplicated. To KNOW CAUSE is to know what the EFFECT **MUST be**. From the simple principles outlined herein and titled "THE SCIENCE OF THE COSMOS" a new science for tomorrow can come into being which is based on Natural Law and could bring to mankind a greater era of peace and plenty than it has ever known. It is with our deepest desire to serve our fellow man that we commend these lessons on the new science unto you.

TOO SIMPLISTIC?

Never! God is total simplicity. These lessons may appear too simplistic--they are not if you change your concept and open to the facts. They are brief for the information does not need take great and massive volumes for the method ALWAYS WORKS. Science now requires massive volumes upon volumes because the system rarely WORKS. You cannot enter incorrect data and expect results other than incorrect. If you dial an incorrect phone number--you will never reach the one you wish at the correct number. Further, the pages are quite "clean" and YOU can amplify this basic truth into volumes which can change the course of human destiny if man will but realize that ALL Creation with its expression in diverse forms springs from and returns to its ONE SOURCE--ITS **CREATOR**.

Down through all ages, man has looked for the answer to himself and his universe **OUTSIDE of himself**. When he at last looks **WITHIN** in God intent, he will wonder why he has always made his life--and his ways and processes of life--so complex.

The Creator's ways and processes are simple as we so often have stated and the time has come when many must make their ways and processes simple also. The world of science can truly lead the way and will if it can recognize the basic CAUSE of all things. It has already gone far in demonstrating Natural Science in ways which have been pointed out in these lessons. Now man has the choice of taking God, his Creator, into the laboratory and working WITH Him by putting Natural Law into full operation or destroying himself through a lack of comprehension of his ONENESS with all things.

How sad that the original receiver of this wondrous information was not present to send the final portions unto you, his brothers. It is, however, exactly as it was to be for the time is only now at hand where the cry of the Phoenix will be heard across the lands.

Many great men of science acclaimed this work--some has been utilized but none made available in its free and simple form because of the Elite greedy adversaries. As you bring these under control, so shall then blossom the wondrous secrets of the universe. Most ones in science simply have not understood Cosmic knowledge and

can't comprehend and accept this contribution--but it shall be given to the open-minded ones who give to fellow-man instead of TAKE.

It has always been thus for those so far ahead of their day. We honor this great and tremendous contribution to MAN from one who KNEW and UNDERSTOOD.

Just as Cosmic brothers have grown far beyond this simple concept--so too shall you. But this is where you start and the rest will be given unto you. GOD WILL WORK WITH YOU; NOT FOR YOU.

Dharma, allow us a respite please. It is time you take a break but we draw near the ending of this particular series and then we can turn to more "personal" things and current attentions. We will have a few more major discussions on the TRANSFORMATION OF MAN, however, so bear with us a bit longer. We are greatly in your debt. Blessings within the Light for our work is well projected and thanks to those who handle it with care and love--it is projected to the masses that ALL MIGHT "HAVE". WHERE GOD DWELLS, NO DARKNESS CAN BE FOUND!

I AM --- GERMAIN

CHAPTER 11

REC #2 GERMAIN

SUNDAY, SEPTEMBER 1, 1991 4:04 P.M. YEAR 5, DAY 016

WHEN MAN SHALL AT LAST KNOW GOD, HE SHALL THEN BE TRANSFORMED.

THE TRANSFORMATION OF MAN

When all is said and done and the facts are laid forth--it is this dynamic knowledge of the identity and Presence of God within the Soul of Man and throughout Nature which is the ultimate goal. This stage for the human race must be attained before it is possible for it to build an enduring civilization of unity and brotherhood. We can give you all the "how to's" and "why's" and "wherefore's" and it is of no consequence if Man fails to attain this KNOWLEDGE.

There is only one reason that man has never known God and that is because he is still in his intellectual infancy and his ideals and practices are still quite primitive and barbarous--for he walks the path of the physical and discards that of the immortal Self.

To know God, man must know what Light IS and, also, energy, gravitation and God's processes in the building of bodies which manifest His Presence and His purposes. And he must know the mysteries of life, death and growth, and of the seed into which even the giant oak disappears but still retains its identity. And he must know how man retains his identity when he, also, disappears.

No man has yet known these things. The concepts of modern sages regarding them are totally unlike God's processes. The conclusions of man regarding them are the conclusions of his senses. His Mind has never yet pierced their illusions. He still senses EFFECTS without knowing their CAUSE.

These things you shall now know--and when you comprehend them within your Inner Self, you will then know God. In this outlaying we shall dive off into the

SPIRITUALITY OF LOVE

This will be the ending portion of this volume and we shall call it a unit as to subject matter. It won't take a lot of drawings--but it is that which of all things, needs heeding lest all the rest be of moot point.

To truly know love as the sole motivating force of the universe is man's primary purpose on Earth. This is WHY the Elite adversaries of LIFE have distorted the meaning of love--to spoil and misrepresent the entire concept into the physical

lustfulness of the flesh desires and senses. If every institution of man's civilization were built upon loving service given in all interchangings with others, your world would be a wonderfully happy one, for only GOOD would then be given for true "love" is only GIVING--misuse of "making love" is only TAKING.

That is what is meant by the spirituality of love, for God is LOVE and God is GOOD. God gives only GOOD to his divided Father-Mother universe and this GOOD is manifested by **giving and re-giving. Nature, which is a manifestation of GOOD, always gives; it never takes.**

GOOD, therefore, is not divided into its opposite expression which is evil. It is forever unchanging.

Deep within man's Consciousness is the knowledge that LOVE is all there is for LOVE is God--and God is all there is.

To "discover" God is man's eternal quest. All of man's earthly experiences have but one purpose--to break the shell of his awareness to himself. His experiences take him down diverse paths and he knows great joy and sorrow as he walks down these self-made paths of life.

When he walks the path of love, he is happy and balanced. The sun shines brightly within his heart even on a cloudy day.

When he walks the path of hate, he is lonely and apart from all that would give him warmth within his heart.

When he walks the path of fear, he dies a thousand deaths in self-doubts and diverse ills.

When he walks the path of greed, he is sick with self-deceit and imprisoned from the light of love which alone can set him free.

Whatever man experiences down his pathway of life, he has an insatiable desire to know the "wholeness" of love. This desire is only faintly known by some Souls who live a sensed-existence, but for the Soul that has unfolded farther along the path of Consciousness there is an everlasting search and longing for that completed circle of love.

Man may experience every kind of success in the material world: money, position and power with the attendant adulation which he believes will completely satisfy his desires. With each accomplishment, there is a faint sense of "something" missing. That elusive "something" is what man is eternally searching for.

Within the lessons is the CAUSE and ANSWER to man's eternal quest, for in the understanding of the science of the universe and man, himself, lies the explanation of Life's Cosmic drama.

To understand the WHY of all things, however, one must truly know LOVE. In this knowledge and realization lies the answer to your eternal quest.

Those who know LOVE **know GOD and, knowing God, know the ecstasy of eternal ONENESS.** The man and woman who are true mates experience moments of oneness with all eternity when they reach that moment of complete **unawareness** of body-sensing. They are then one in the God-Light. This is the spirituality of love.

If men and women would search for their spiritual and mental mates rather than allow their physical senses to govern them, divorce would be impossible. There is nothing in this universe that could separate a man and woman who know and share true love, for such a union is truly a marriage of God (Love). True love is eternal love and two souls who have "found" it will find each other again and again in life after life.

THE LIVING OF LIFE

The purpose of your whole life's experiences is to find and KNOW your Creator. The laws of Creation are inviolate laws which man can only know through a basic understanding of the Creator's ways and processes. The principle which underlies all Cosmic Law is LOVE--and this, perhaps, would be better understood if we used the three dynamic words "RHYTHMIC BALANCED INTERCHANGE" (Now, you knew you would hear about this again!).

The meaning of RHYTHMIC BALANCED INTERCHANGE is **equal giving for equal regiving**--and not equal receiving—because every pair of opposites in Nature is balanced equally, even unto life and death. What goes into the ground must equal that which comes out of the ground. BALANCE is the fulcrum of this lever of equal giving and regiving.

Love means equality between all things. It means equal division of all interchange in industry instead of bargaining so one group gets the better of another. These principles are as important to the meaning of love in industry as the balance of love and sex is between man and woman.

There is an old expression which says: "Tis love which makes the world go round." No more appropriate expression could be devised to express the real meaning of "balance" in the interchange of all things--nor its lack thereof to express the total unbalance. It is a well known fact that geniuses and Illuminates understand this principle of love for they give all they have without expecting material reward. Remember that no matter how many may be in an audience, you play for only one--paint for only one, sing for only one--Self and God. You can only give of that which is shared for the artist must first please self.

HOW TO KNOW GOD

There is only ONE way to know God and that one way is through **knowing and living His Law of Love. That one way is found through inner vision which inspiration awakens into physical expression.**

All down the ages, man has felt the necessity of knowing that there is a God who created him. His desire inspired him to create idols which he formed in the image of himself, for he had not yet reached the stage in his Soul-unfolding where he **knew** the Light, which God is, that centered him.

Man knows God when his awareness of the God-Light is awakened in him. This awakening comes into being by diverse experiences and that is why we say **every** experience is GOOD. The experiences which bring man a great sense of aloneness most often are the ones which awaken the Light of God in him--for where there is sorrow, there is solitude and then a point of rest is reached. Man's fulcrum, which is his **balance**, lies **within himself**. To "discover" and know his fulcrum is his moment-to-moment task. That is why we so often stress the fact that the incidents in your lives are of **secondary** importance but your adjustment TO those incidents and what you gain FROM them is of **PRIMARY** importance.

When you at long last come into realization of what is the purpose of life, you endeavor to use each moment constructively for you know that when you overcome a weakness in yourselves, you have gained strength in your character, and **your individual destiny is created by your individual character**. That is why philosophers of all time have counseled you to **seek within and know yourselves**.

To know yourselves is to know all men, for all men have identical God-like potentials which are just awaiting their awareness of them.

Immanuel said: "Seek ye first the Kingdom of God within and all else shall be added unto you."

Socrates said: "Know Thyself."

The people who give most to life are usually the ones who have known the greatest personal suffering, either mental or physical. The deeper the suffering, the deeper the inner searching for the answer. From that deep inner Source of all-knowledge comes the clear answer.

There are many examples of man's spiritual awakening in desolate solitude. Men such as Socrates, and others would never have given the great wealth of their thinking to the world but for their aloneness in deep sorrow arising from personal tragedies. Kahlil Gibran, in his timeless and beautiful book "The Prophet", wrote: **"The deeper that sorrow carves into your being, the more joy you can contain"**

No man has known greater sorrow on earth than did the one called the Christos, and the more he suffered, the more he loved and gave. Deep within the heart of the persecuted is born pity for the persecutor, for the suffering Soul is often awakened and knows its true identity with the God-Self and, realizing this, is filled with pity for the unknowing one. I watch, for instance, as this very example flows forth from this scribe who understands it not.

Solitary confinement can also awaken Cosmic awareness. It is witnessed that many men and women serving prison sentences have found their true selves behind prison bars. You are, no doubt, familiar with the statement: "The greatest sinners have often become the greatest saints."

When reincarnation is actually fully comprehended, capital punishment will cease for the "body" that is put to death is NOT the being and that being or "Soul" will return in yet another manifestation **at the same stage of Soul-unfolding as it departed. If it left with a sense of hate and revenge, it would return with the same negative thoughts and would play the same kind of "role" as it did in its previous incarnation.** If the offender had an opportunity for solitary confinement prior to the death of his body, he could "find" himself. In other words, he could have a cosmic awakening and his desire for revenge would be replaced with a desire to love. In the silence of man's Soul is the seed of God's love. In that love is only beauty and a desire to give--and in giving is unbounded joy.

In love there is freedom--every kind of freedom--for there can be no hate, fear, greed, jealousy, covetousness or hypocrisy where there is all-enveloping love. When a man has the opportunity to know "himself", he knows the exquisite ecstasy of his true Self--the Self which all men are destined to find and know whether it be in this life or a million lives from this one brief expression which, at best, is but a breath in the timelessness of eternity.

What is meant by "The truth shall make you free" is that when you really know TRUTH, you will LIVE TRUTH--and "TRUTH" is love, honesty and beauty--and you will desire only to GIVE for you will know that you can fulfill your purpose on Earth only by giving so that you may, in turn, be regiven. In other words, if the man who had taken a life or committed some other unpardonable crime had an opportunity to "know himself" in solitary confinement, then when he again returned to earth he would not commit the same crime for which he lost his life (body). An understanding of God's scientific ways and processes brings full comprehension of reincarnation, which is the repetitive principle in Nature. That is why it is of utmost importance that Universal Law be understood and practiced in all human relations. An adherence to Universal Law will dispel individual and worldwide inharmony and the leaders of all countries would endeavor to work cohesively for the peace and prosperity not only of their own people but of the people of the whole world. They would then truly be "their brother's keeper".

Only basic knowledge of the science of the universe and man, himself, will bring this utopian state to earth, but the agony and sorrow of man's awaiting is his alone.

**"ALL MEN SHALL COME TO ME IN DUE TIME BUT
THEIRS IS THE AGONY OF AWAITING"**

MANIFESTATION OF LOVE IN CHARACTER

The great men of all time were men of character--men who have reached such supreme heights of wisdom, justice and righteousness that it can be said of them that they closely emulate God on earth.

God, the Creator, is LIGHT. The language of Light is LOVE. Men of character are the Light of the world. Their every deed and action is based upon love (balance).

The Light of the world of today is going out and the world sickens unto death because character in man is at its lowest ebb in seven thousand years. As man's destiny is governed by his character, so is the world's destiny governed by the character of the people of the world.

If we are ever to restore our civilization to a state where the people of the earth can live happily together as a one-world family, we must build Godly people whose innate nobility is so basic that it would be impossible for them to act in any other than a noble way.

Let us review what we mean by that. A man of fine character is one who can be defined as a perfect gentleman. The best definition of a perfect gentleman is that he is one who can always be counted upon to do the right thing. If your world were made up of people who always did the right thing, you would have no crime, no prisons, no wars, no need for locking your doors for protection, and no unhappiness resulting from the wrong things people are forever doing.

A gentleman, or gentlewoman, of high character could not possibly speak ill of anyone nor repeat one word of malicious gossip. Neither could he take the slightest advantage of anyone in either social or business affairs, for he would know that gaining such an advantage would be at the price of his own soul.

A noble man, or woman, of high character looks noble and beautiful no matter what size, shape or color his physical features are. His nobility brings a radiance to his personage, a radiance which magnetically draws others to him. He stands apart like a light from his fellowmen. The power of his presence overwhelms and overpowers every lesser character. There is an ageless quality about him.

Such a person walks with a dignity in his, or her, bearing that makes heads turn as he passes. One says to oneself as he passes: "I wonder who that distinguished person might be?"

There is something infinitely greater about such a person than what one sees with one's eyes. There is an invisible Presence encircling him which seems more real and overwhelming than the visible man himself. That Presence hovers over the very works of such a man, and this, one can **feel** but cannot see. One stands before his work with reverence and is exalted with inspiration if it be spoken word of wisdom, the interpretive rhythm of a poem or symphony, or a gesture of friendliness bestowed upon a neighbor by the wave of his hand.

How does such a man acquire his nobility and his power? How is it that he has found self-sufficiency and competence in a lonely and incompetent world? How is it that he has found complete inner joyousness and insulation from frustration in this crime-ridden, warring world of ravenous humanity where practices of inhumanity to man conspicuously overshadow kindly actions or love-inspired deeds?

From what inexplicable source comes the power of such a noble character as Mahatma Gandhi who quietly conquered a great nation, what of a Cesar Chavez who quietly stands before his farmworkers in front of the insecticide poison tank? The nation's armaments and high-walled prisons are not able to detain these men. What better term is there to explain such power than to say that goodness and righteousness triumph over the power of might exerted against them.

Various practices in industry today breed disloyalty and contempt among employees. The lash of the tongue is resisted as much as the lash of the whip. The master and slave relationship is not conducive to lasting progress and success. That is why such organizations as unions were originally formed, to see that workers were given a fairer deal financially and spiritually. But now, however, the worker is in the driver's seat and instead of working for character, he all too often is working solely for material gain.

Until both Capital and Labor realize that LOVE must be the basic factor in their working relationship, neither side will be happy and progressive.

Bargaining can never bring success because it always leaves one side or the other with a sense of loss, whether the bargaining be between individuals, unions or countries. A settlement based upon the love principle--and this means **balance**--is the only one that will stand for all time.

Character building will destroy the animosity which has always existed between Capital and Labor because commerce would be viewed from an entirely different angle. When man knows his purpose on earth, his work and everything he does will become more meaningful. Knowing that whatever he does, he does for himself will give color to his life. Is this not an interesting concept?

The "purpose" of life has never been universally understood and so Capital and Labor resent each other for quite different reasons. Until UNITY is established between employer and employee, there can be no progress in industry.

Industry is actually THE very thing that could be the CATALYST FOR WORLD PEACE.

You can grow in awareness of God only through your experiences, as we have stated over and over again. Experiences mean action and interchange. Your lives must express balanced interchange and this produces motion of bodies. Bodies, in order to survive and function, must have fuel. To fulfill the Law of Creation itself, you must FIRST GIVE. Therefore, you must first work in order that you can EARN the food you eat. If there were no money interchange, you would still have to work to eat for you must always plant the seed, nourish the soil, harvest the produce and prepare the meal. Therefore, the food you eat is truly a manifestation of **loving service given to yourselves, for without loving care man produces little and the body dies of starvation .**

This truth has been made startlingly clear in those countries where labor is regimented to such a point that love has been submerged and the "slave" has lost all desire to live. Only work performed with love is lasting and fruitful.

Food cooked with love feeds one's Soul as well as one's body. But that cold sandwich served and shared with love is greater than the banquet feast prepared as a "chore".

Your world has become so mechanized and "classified" that the loving personal interchanges are disappearing. Parlor games have been replaced by "necking" parties and juvenile delinquency is ever on the increase for lack of loving guidance. Young people should be given the opportunity of playing games in sports for they need physical outlets for their growing bodies. Working at something constructive or sharing is a necessary ingredient for happy, healthy bodies, and happy, healthy bodies are productive bodies.

Work and play, however, must be balanced. If either side outweighs the other and balanced action ceases, joyousness and productivity also cease and the end result is dissatisfaction. Dissatisfaction leads to trouble. Always in the equation must also be responsibility for actions.

Character is destiny--and you create your own destiny. **"Your own shall come to you"**

KINDNESS

The greatest quality of a noble character is kindness--simple kindness given with love. What is kindness but love in action? The more love you put into anything, the more inner joy you experience. And the more inner joy you experience, the more love and

joy you extend to others. This joy--expressed in kindness--becomes a snowball and once it starts rolling, it never stops and gradually becomes a world snowball.

Either the world becomes a "snowball" of LOVE or it will disintegrate into "nothingness". Which will it be, good brothers?

God has given you a beautiful world in which to experience and everything to make life perfection, but you must do your part, also, for unless you do your part by first giving to life, you cannot be regiven. Give kindness and kindness will be regiven to you. A wounded animal who is given kind attention will lay down its life for the one who saved it. If animals do this, why not extend the same kindness to your fellowman?

There are countless people in the world today who are hitting back at life because they perceive themselves to have been injured. One hurt after another has piled up within them and now it is exploding. **This is the deep-rooted CAUSE of most of the trouble in the world today.** Man began innately kind but, being kind, he is often abused and then goes in reverse and wants revenge.

When men and women make the giving of love, thoughtfulness and kindness their **GREATEST** concern, all else will take its rightful place.

HUMILITY

Humility is love personified. How could one who knows love be other than humble, for he knows the basic longing of all souls to express greatness. This desire to express greatness is man's Soul-ego--not his little ego which is expressed through his "senses" in self-aggrandizement and other selfish ways.

Humility is the mark of a truly great man. A humble man is fully aware that no matter how great his accomplishments are, he knows he could do better. Because of this, he is embarrassed when praised.

Humility grows as God-awareness unfolds. It brings a sweetness and gentleness which is irresistible in young and old alike.

A humble man is a powerful man who is respected and sought after as a leader. **Such a man's judgment comes from his Mind-knowing and not from his sensed-thinking.** That is why true humility should be the goal of all your world leaders, for the destiny of mankind is in their hands. I don't believe you will find very much humility around Kennebunkport or the White House--or anywhere around the state capitals or Washington, D.C.--surely not around the Royal Palace in London.

HONESTY

This you will not find around any of the halls of justice or politics either. The character trait of honesty is not only essential to your personal peace and happiness but it is VITAL for world peace and security. You have NONE!

THERE CAN BE NO SUCCESSFUL INTERCHANGE IN HUMAN RELATIONS, WHETHER INDIVIDUAL OR COLLECTIVE, IF HONESTY IS NOT THE FULCRUM OF THAT INTERCHANGE.

Honesty is the balance wheel for any business transaction because unless there is honesty there is ultimately bound to be failure.

We are, today, witnessing so much dishonesty between nations that the people of the world feel very insecure. This insecurity is the root cause of poor business. An insecure man does not spend, for he is filled with fear for the future instead of faith.

Trust between all peoples must be restored. ***TO HAVE TRUST, YOU MUST HAVE HONESTY.***

Thank you for your long hours this day. With this extra time of writing I believe we can finish this JOURNAL by tomorrow evening. I realize we have you work triple time on every holiday which comes but the interruptions are less and so much more gets done. Will it not be better to "rest" in "peace" than in "slavery"? Allow us not to leave our task unfinished for that unfinished sequence may have been the one to turn the "war". So be it.

I AM --- GERMAIN

CHAPTER 12

REC #1 GERMAIN

MONDAY, SEPTEMBER 2, 1991 7:59 A.M. YEAR 5, DAY 017

MONDAY, SEPTEMBER 2, 1991

LABOR DAY

Ah, you ones have such wondrously strange celebrations. You celebrate "Labor Day" by "not" laboring and you run about in celebration in the midst of the oncoming biggest depression in the history of your world. Yes, you are a strange sort of humans, but then, it IS your experience--not mine, except in this manner of service.

I would comment on another strange phenomenon. Rick received from one of your major "nonviolent direct action to end the arms race--THE AMERICAN PEACE TEST" group: "Thanks for the copy of MURDER BY ATOMIC SUICIDE, I have not read the whole thing but I have glanced through it. You are right, it is interesting.

"I am afraid that we have decided we can not allow you to use our mailing list to send out information on this book. It does have somewhat to do with the controversial aspect of the information provided by the book, and also with the decision to just send out information on the book rather than the book itself. We feel that it would be easy for people to NOT understand the true nature of the book when ordering it.

But thanks for checking with us. Good luck with your work, In peace, Reinard Knutsen."

Brothers, this is what will kill you--the ridiculous facade which is established by your "so-called" freedom groups and "demonstrations" groups. There is no real intent to stop anything, just keep all of you THINKING that you are doing something. Perhaps you would like to send them a few hundred letters; after all, it is only the destruction of your planet in point. P.O. Box 26725, Las Vegas, Nevada 89126-0725--Testing Alert Hotline 702-386-9831. We do note however that the listing of some 80 to 90 nuclear organizations exist and Rick received the listing from two other sources. What do you do? If you wish to restore your planet, YOU KEEP RIGHT ON KEEPING ON! GERMAIN, HERE, WILL CONTINUE TO SERVE UNTIL WE BRING YOU HOME AND BEYOND FOR I, TOO, AM IMMORTAL AND IT IS TIME YOU RECOGNIZE YOUR OWN IMMORTALITY--FOR YOU ARE COMMITTING ATOMIC SUICIDE EVEN IF YOU CONTINUE WITH JUST NUCLEAR ELECTRIC POWER.
SO BE IT.

You have entered the economic crash spoken of in past JOURNALS. Please do not be so foolish as to think anything has changed excepting the tightening of the noose to choke position--you are dying, world. Hatonn shall write of these things later this day for your *EXPRESS* and many, many are seeing and hearing. The crash began right on schedule and you got shot fatally--you just have awaited instruction from the would-be "Kings" to fall down. AMERICA--you have well over 16 MILLION workers out of work and millions more to be released in the next couple of months--you will have a most bleak Christmas Season, planet Earth. I can only suggest that you get this information and USE IT. Take your brother's hand and unify lest it move beyond recovery.

Dharma, allow us to move on with the subject at hand for it is a joyous and glorious TRUTH and man has to change none save Self to use it.

GOD'S PURPOSEFUL INTENT FOR MAN
and
THE POWER OF MOTHER LOVE

We will make an effort herein to explain God's purpose in placing man on earths of Creation's starry systems and how far man has progressed to this date.

Science has tried to prove how life came into the world. In so doing, many scientists have left God entirely out of their thinking by attempting to prove that life came into the world through the congealing of a mythical ooze, or a primordial substance, as a basis of life. Intelligence is presumed to come through the development of the bodies thus created, and each body is presumed to have a separate mind of its own.

It seems strange that the existence of water was not questioned as it aided in creating the substances which gave birth to humans and forests and millions of other **living things. Do you not see that the truth was there in the beginning and became distorted in the retelling and in the tampering to suit the would-be rulers? IT IS SO OBVIOUS THAT IT STARTLES THE IMAGINATION. ONES WHO WOULD HEAR THE TRUE STORY FAILED TO UNDERSTAND AND PROJECTED FORTH THE ERRONEOUS PERCEPTION AND THROUGH THE EONS OF TIME YOU END UP WITH NO TRUTH.**

This is tantamount to saying there is no Creator. It certainly was not intentional for these scientists to leave God out of His Own Creation for most of them would be shocked if they were accused of being atheists.

In order to describe and analyze the cause of man's present condition, we must go back to the beginning of history as you have experienced it. Even before the emergence of man from some Sahara jungle swamp, there have been killing instruments such as the stone hatchet and the spearhead which are even at this date being unearthed. These indicate that war began in the jungle, but no one has reasoned WHY. Man began to conquer man because he resented another getting the food he was hunting for himself.

From the early dawn of life, greed multiplied in him and has continued to do so up to this very moment when man still preys upon man.

Greed brought misery to the Egyptians, the Hebrews and the Chinese thousands of years before the story of Adam being the first man to be born on earth came into being--how totally absurd.

A colossal mistake was made in this Adam and Eve story which gave no import to woman because she was believed to have come from the rib of man. (If anything, this story should have been given in reverse since man is conceived, nurtured and given birth from the womb of woman.) It made woman inconsequential and a creature designed to obey man. To make the sting still greater, man claimed that God cursed her for creating sin.

Woman was always considered more lowly as a mental mate and still is in many countries. In the days of the Pilgrims, women were subjected to strict obedience and claimed to be sinful. Remember the scarlet letter "S" branded on the forehead? The woman--not the man who had equally "sinned" and thought up the sin in the first place--was forced to wear this dreaded sign on her forehead or breast for the rest of her physical life--often dying and returning with vengeance on her mind to "get even with the male" and I believe, in general, she has accomplished the task. And man has no notion of what to do about it now--he has lost his helpmate as his very partner and loving, nurturing mate has turned into feminists and controllers. The role of man as "household support" has been lost forever as more and more women have had to go forth from the family circle to feed and clothe the offspring of this "sexual rite/right".

The life of a woman back in those olden days became that of a slave--a commodity. Man was the master of the house then, and he remains so in many Asiatic countries today. In the Orient and most Mediterranean countries, women slaved for their masters who ruled them as strictly as they would their slaves and work animals.

Everyone is familiar with the Arab who sat in front of his tent and let his many wives work for him--how about Sabah (of Kuwait) and his 80 wives? You know, the one you just went to protect his Kingdom for? The one you allowed your own sons to be killed to reestablish in his thronedom? These wives tended his goats, his camels and horses and did all the work in the fields. The wealthy Arab kept his wives in harems where they were watched over by "keepers", men who had been robbed of their manhood and were known as "eunuches". Today there is some change which has developed gradually in countries like Arabia and Egypt. It is nice to see dignity slowly coming to women by the removal of the veil here and there and allowing them to converse with men. Note however, that this is still quite a facade for the Arab woman still may not drive and the Arabian women are still not permitted to sit at the table with their men although they are the ones who prepare the meals. Yes, beloved American women--these are the very kinds of people you sent your sons and your own daughters to "restore" order to.

This indicates how far away from the goal of "equally divided pairs of opposites" your civilization still is and is a reflecting comparison between past and present ages.

Well, you might say, "Old George treats Barbara pretty well!" Indeed and guess who had the most power and money at the onset of their relationship??? With ones like this it is not LOVE and not even "sex", it is a joint sweep to attain massive control and power! The offspring are to their ears in every dastardly project on the globe. When this kind of morality is handed down from generation to generation--what expect ye of a civilization?

Let us return to the days when man first made himself the greatest enemy of himself, **which he is to this very day.**

Greed was generated by the invention of money and the usury system in Babylon--now, you knew that, didn't you? Hatonn has told you this several times and even the Bible and Immanuel told you this. With money came the desire for power, power to control other men. And increasing power brought man nearer and nearer to his degradation.

As man's greed for money and desire for power continued to increase, heinous crimes including murder were unhesitatingly being resorted to. Holdups and killings had become so commonplace that even children killed for the mere pleasure of killing, often killing their own fathers and mothers.

Yes indeed, Hatonn, or myself, will get back to the Khazarian subject as quickly as we can do so for there in that historical documentation of the species during those early days was plotted the roadmap unto today.

We will refer to the people of the moment as "Jews" for that is what they later labeled themselves and most of the historians refer to the group as such for meaning and understanding. Harry Shapiro's contribution, THE JEWISH PEOPLE: A BIOLOGICAL HISTORY, gives great insight into the times which evolved from these early historical people.

"The wide range of variations between Jewish populations in their physical characteristics and the diversity of the gene frequencies of their blood groups render any unified racial classification for them a contradiction in terms. For although modern racial theory admits some degree of polymorphism or variation within the racial group, it does not permit distinctly different groups, measured by its own criteria of race, to be identified as one. To do so would make the biological purposes of racial classification futile and the whole procedure arbitrary and meaningless. Unfortunately, this subject is rarely wholly divorced from non-biological considerations, and despite the evidence efforts continue to be made to somehow segregate the Jews as a distinct racial entity."

My only point at this writing is to give insight into the mingling of races and cultures and not to make a point of morality. The "Jews" however, demand to set themselves aside and have their own religion and nation and be the ONLY nation in the world allowed to do so. So, the subject must be addressed in any historical document of earth evolution.

There was a twin phenomenon which developed and continued to blossom--diversity in somatic features and conformity to the host-nation . The "Jews" were "business people"--merchants and bankers, lenders and money managers. So what of the so-called, self-labeled "Jews": are they of pure race, modified more or less by environmental influences, or are they a religious sect composed of racial elements acquired by proselytism and inter-marriage during their migration in various parts of the world? Let us see what one of their own historians reports:

"Beginning with Biblical evidence and traditions, it appears that even in the beginning of the formation of the tribe of Israel they were already composed of various racial elements... We find in Asia Minor, Syria and Palestine at that time many races--the Amorites, who were blondes, dolichocephalic, and tall; the Hittites, a dark-complexioned race, probably of Mongoloid type; the Cushites, a negroid race; and many others. With all these the ancient Hebrews intermarried, as can be seen in many passages in the Bible... ."

The prophets may thunder against "marrying daughters of a strange god", yet the promiscuous Israelites were not deterred, and their leaders were foremost in giving a bad example. Even the first patriarch, Abraham, cohabited with Hagar, an Egyptian; Joseph married Asenath, who was not only Egyptian but the daughter of a priest; Moses married a Midianite, Zipporah; Samson, the Jewish hero, was a Philistine; King David's mother was a Moabite, and he married a princess of Geshur; as for good King Solomon (whose mother was a Hittite), "he loved many strange women, including the daughter of Pharaoh, women of the Moabites, Ammonites, Edomites, Zidonians, and Hittites..." And so the *chronique scandaleuse* goes on. The Bible also makes it clear that the royal example was imitated by many, high and low. Besides, the biblical prohibition of marrying Gentiles exempted female captives in times of war--and there was no shortage of them. The Babylonian exile did not improve racial purity; even members of priestly families married Gentile women. In short, at the beginning of the Diaspora, the Israelites were already a thoroughly hybridized race. So, of course, were most historic nations, and the point would not need stressing if it were not for the persistent myth of the Biblical Tribe having preserved its racial purity throughout the ages.

Another important source of interbreeding were the vast numbers of people of the most varied races converted to Judaism. Witness to the proselytizing zeal of the Jews of earlier times are the black-skinned Falasha of Abyssinia, and this is proven by the raids into Ethiopia this very day to recover "black" Jews into Israel. But world, beware, the Khazarian Elite of this new state of Israel do not plan to intermingle--they plan to enslave the lesser races for themselves, the Khazar Elite.

Jewish proselytizing reached its peak in the Roman Empire between the fall of the Jewish state and the rise of Christianity. Many patrician families in Italy were converted, but also the royal family which ruled the province of Adiabene. Philo speaks of numerous converts in Greece; Falvius Josephus relates that a large proportion of the population of Antioch was Judaized; St. Paul met with proselytes on his travels more or less everywhere from Athens to Asia Minor. "The fervour of proselytism", was indeed one of the most distinctive traits of Judaism during the Greco-Roman epoch--a trait which it never possessed in the same degree either before or since--until NOW. It cannot be doubted that Judaism in this way made numerous converts during two or three centuries. The enormous growth of the Jewish nation in Egypt, Cyprus, and Cyrene cannot be accounted for without supposing an abundant infusion of Gentile blood. Proselytism swayed alike the upper and the lower classes of society. BUT THESE WERE NOT SEMITES, SO WE REPEAT--THE JEWS WHO ACCUSE OF ANTI-SEMITISM, THOSE WHO SPEAK AGAINST THE ACTIONS OF A GROUP OF SO-CALLED "JEWS"--OPENLY LIE FOR THEY ARE NOT EVEN JUDEANS NOR JUDAISTS AND CERTAINLY ARE NOT SEMITES.

DURING THE PERIOD OF TIME BETWEEN 1921 AND 1925, OUT OF EVERY 100 MARRIAGES INVOLVING JEWS IN GERMANY--42 WERE MIXED. IT IS NOW PROVEN THAT IN THE HOLOCAUST THERE WERE A MAXIMUM OF SOME 300,000 PERSONS KILLED--EXTERMINATED. THESE WERE THE JUDAISTS, MANY OF SEPHARDIC LINE, OR "TRUE" JEWS. THEY HAD SOJOURNED IN SPAIN FOR MORE THAN A MILLENNIUM. THE ASHKENAZI JEWS OR "KHAZARIAN" JEWS WERE THE MAJOR EXTERMINATORS IN THE GERMAN HOLOCAUST. HATONN WILL BE WRITING ON THIS AT GREAT LENGTH IF YOU WILL BE PATIENT.

WHY DO I BRING THIS UP AGAIN NOW? BECAUSE THIS GROUP OF ELITE BANKSTER CONTROLLERS ARE THE VERY ANTI-CHRIST OF WHICH HISTORY AWAITS THE ARMAGEDDON. IT IS TIME YOU ONES QUIET YOUR BIGOTRY OUTCRY FOR YOU DON'T KNOW OF WHAT YOU SPEAK! YOU ARE CHILDREN OF THE LIE AND IGNORANT TO HISTORY AND IT WILL BE YOUR ENSLAVEMENT AND DOWNFALL.

I quote briefly from the 1920 updated instructions of the Zionist Elders Protocols: No. 17. *"Let us take care not to hinder the marriage of our men with Christian girls, for through them we shall get our foot into the most closely locked circles. If our daughters marry Goyim (Gentiles, Semites, Shemites) they will be no less useful, for the children of a Jewish mother are OURS. Let us foster the idea of free love, that we may destroy among Christian women attachment to the principle and practices of their religion."*

Also, for Dharma, who cannot understand what has happened to "nice retired people" in this property case with the S&L, and RTC: Protocols update of 1920: No. 13: *"We have already established our own men in all important positions. We must endeavor to*

provide the Goyim with lawyers and doctors: the lawyers are au courant with all interests; doctors, once in the house, become confessors and directors of consciences." And further: "If one of our people should unhappily fall into the hands of justice amongst the Christians, we must rush to help him; find as many witnesses as he needs to save him from his judges, until we become judges ourselves." Now, chela, there was ample reason for Mr. Horn to include an *EXPRESS* dealing with the subject at hand--INTO THE COURT CASE. The expectation is to sort out a JUDGE who will serve his master, the Banksters of Khazar. The case involves an S&L owned and operated by the most Elite of Elite and next the RTC in coalition with those Elite and headed by one of their own, Seidman. All the legal profession has done is call false witnesses and false "law" to destroy you-the-people. By any accounting the case is far more expensive to both sides than any charges could possibly be regarding the property. THEY CANNOT ALLOW YOU TO WIN--AND THEREFORE, FOR THE VERY SAKE OF YOUR NATION--YOU CANNOT AFFORD TO LOSE THIS CASE. When the Bank of America bought out Santa Barbara Savings and Loan--like usual as instigated by Mr. Seidman recently--they only took the assets of value and left you-the-people with the damages, defaults and problems. You must wake up America for you are already in the trap and the Executive Order signed and in force--for your execution!

This is the increasing power which has brought man nearer and nearer to his degradation.

As man's greed for money and desire for power continued to increase, heinous crimes including murder were unhesitatingly being resorted to, as I said above. You are back again to the days where it is quite prevalent for children to kill for the mere pleasure of killing--often their own fathers and mothers--you had best read your non-news.

In comparing past ages with the present, we will return for a moment to the early days of ancient Egypt in order to describe the great progress that took place during the Age of Character which James Henry Breasted so well describes for you in "THE DAWN OF CONSCIENCE". Egypt gave you your first great knowledge of the following cultural arts which were then at their highest peaks, higher than has ever since been reached in all history. Thus comes this day the Goodly Company which brought about that very enlightenment:

ARCHITECTURE: As demonstrated by such superb structures as the great Temple at Karnak, which took four or five centuries to construct, the Pyramids of Gizeh, and the Pyramid of Amenemhet III at Dahshur.

ASTRONOMY: As demonstrated by the Gizeh pyramid. These ancient men of thousands of years ago knew the position of the North star and the rate of speed at which it traveled per year and built a long stairway from the opening to a hole in its side through which a man of even **this** century could view it.

MATHEMATICS: As demonstrated by their measurements of the Earth's circumference and diameter with such accuracy that it enabled them to make the first calendar. It also enabled them to place the faces of the pyramids at such angles as to make them in accord with the orbits of the Earth around the sun.

SCULPTURE: As demonstrated by such superb stone and bronze sculpture as the portrait of Amenemhet III, carved ivory plaques depicting Egyptian divinities from the Hebrew Temple at Samaria, and the black granite stone head of Ptah of Memphis.

POETRY: As demonstrated by such superb poetry as the following which James H. Breasted quoted in his great writings:

The Corruption of Men

*"To whom do I speak today?
Brothers are evil,
Friends of today are not of love.*

*To whom do I speak today?
Hearts are thievish,
Every man seizes his neighbour's goods.*

*To whom do I speak today?
The gentle man perishes,
The bold-faced goes everywhere.*

*To whom do I speak today?
He of the peaceful face is wretched,
The good is disregarded in every place.*

*To whom do I speak today?
When a man should arouse wrath by his evil conduct,
He stirs all men to mirth, although his iniquity is wicked.*

*To whom do I speak today?
Robbery is practiced,
Every man seizes his neighbour's goods.*

*To whom do I speak today?
The pest is faithful,
(But) the brother who comes with it becomes an enemy!*

*To whom do I speak today?
There are no righteous,
The land is left to those who do iniquity."*

The capstone of all Egyptian poetry was the Psalms which were passed down through the centuries and were later accredited to King Solomon. This is the most beautiful book in your Bible. Let us look:

Egyptian Psalm:

*"Bright is the earth when thou risest in the horizon;
When thou shinest as Aton by day.
Thou drivest away the darkness.
When thou sendest forth thy rays,
The Two Lands (Egypt) are in daily festivity.
Men waken and stand upon their feet
When thou has raised them up.
Their limbs bathed, they take their clothing,
Their arms uplifted in adoration to thy dawning.
Then in all the world they do their work."*

Bible version, Psalm 104:22-23:

*"The sun ariseth, they get them away.
And lay them down in their dens.
Man goeth forth into his work
And to his labour until the evening."*

UNIVERSAL CREATION

Egyptian Psalm

*"How manifold are thy works!
They are hidden before men
O sole God, beside whom there is no other.
Thou didst create the earth
according to thy heart."*

Bible version, Psalm 104:24:

*"O lord, how manifold are thy works!
In wisdom has thou made them all.
The earth is full of thy riches."*

We cite these because that early civilization was the first to believe in and speak of the ONE GOD, which no other civilization since then has until this present one. The ten commandments have not been observed during the thousands of years since this Egyptian Age of Character--but a few of you keep struggling in service unto that ONE GOD AND WE HUMBLY ACKNOWLEDGE YOUR SERVICE.

In those days, if a youth offended his father, it was never because of crime but because of unrighteous thinking. If he went too far and exhausted his father's patience, his father would open the door and command the son to walk out toward the sun--which symbolized their God of Righteousness--and remain there until he regained his righteous thinking. No one would help him in any way for everyone respected the father's judgment and wishes.

Now, it may seem strange but these most righteous people were so affected by the Babylonian invention of money that they developed complex systems of power in their greed and eagerness to acquire more money. They even hastened their own degradation and destruction by selling absolution from sin for a price, *a practice which has been repeated centuries later by people of your own age.*

Your Oscar Wilde describes man's degradation truthfully when he said:

I must say to myself that I ruined myself, and that nobody great or small can be ruined save by his own hand.

At this time, also, the master and slave state began with man being the master, and woman the slave, a practice which was greatly aided by the Adam and Eve story. To this day, man rules and woman serves in many places. **Men head every institution of command throughout the world and women are made dependent upon them for their existence--a most subtle enslavement.**

We can truthfully state that the greatest crime that man has committed against civilization's strong growth is that of refusing to recognize woman's mentality as being equal to his own, and the only time you can get your world in balance is when man realizes that there **must be EQUAL INTERCHANGE** between man and woman--and all other created things, both mineral and vegetable, animate and inanimate. You can see the unbalance now swing in greater measure as woman overstretches to TAKE that balance--which only creates more unbalance.

EVEN THE SPECTRUM OF THE SUN MUST INTERCHANGE EQUALLY, EACH COLOR WITH ITS OPPOSITE SEX MATE, TO KEEP THE UNIVERSE IN BALANCE.

Science recognizes this principle. It has made a law of it which reads: **Every action and reaction are equal and opposite.** But Science is not consistent in practicing it with relation to the equality of woman.

One of our main purposes in giving this information is to give you the science of this two-way universe which is expressed in every department of Creation through the **equal male-female principle.** This unbalance causes more friction and hatred of one sex for another than all unbalances. The world will destroy itself by its own hand unless it reverses its practices and gives equal mental recognition of one sex with the other. World balance must be accomplished in order that you may have world peace.

MAN AND WOMAN ARE THE WORLD SO IT MUST BEGIN WITH THEM!

A break please, chela.

I want to acknowledge another point to Dharma, if I may--for her own consumption. As you sit to write hour after grueling hour I must remind you of a friend who stated your almost identical words many years ago: **William Lloyd Garrison, a 19th century abolitionist, whose paper was the LIBERATOR, gave his own expression of your reflected feelings concerning this which has come upon you and that of losing your constitutional LAW: "On this subject I do not wish to think, or speak or write with moderation. I will NOT equivocate. I will not excuse. And I WILL BE HEARD."**

Yes, Dharma--YOU WILL BE HEARD!

I AM --- GERMAIN

CHAPTER 13

REC #1 HATONN

WED., SEPTEMBER 4, 1991 10:24 A.M. YEAR 5, DAY 019

WEDNESDAY, SEPTEMBER 4, 1991

First, briefly, I, Hatonn, need to speak with you. So much happened on the yesterday which needs expression and instructions but we will not take Germain's precious time in the discussion herein. I ask for a meeting early enough this evening that we can have immediate discussion about the upcoming group session in which I ask participation. They are in no way in conjunction with the publications but are a most personal series of ongoing support opportunities wherein we can utilize group "numbers" in an attempt to structure HOW to come into personal capability to get through these tough times which blast you with everything from addictions to simple distress. All may not wish to spend the time--certainly all participation, as always, is totally optional and we can discuss it before the meeting with the Pilot Group speakers this evening. I will have to warn you now, some are literally controlled by very real dark energies--with the thrust to destroy the entity housing such energy and to attack "leaders" through these avenues. In some instances it is now reached critical proportion and must be stopped.

No one will, please, error by any supposition that what we do is in any way a "religious" "thing". It will be equated more appropriately to Alcoholic, Overeaters, drug, etc., Anonymous "addiction"-handling with the twelve steps expanded and with the assistance of more in-depth TOOLS. The full intent is to set up a working guideline, with the tools, and then they can be available to all--anywhere. If mankind cannot find his balance in this evil infested world, what we do otherwise is quite hopeless for the individual is binded by the shackles of daily bombardment and depressed hopelessness.

GUN CONTROL?

I thank "Orion" for sending a couple of articles in support of what I have been telling you: One--(AP) *"Federal agents arrested hundreds of people on firearms charges Thursday in a nationwide roundup of what one official called "the cream of the crud" behind violent crime. Many could face prison terms of at least 15 years for violating federal gun laws [this is JUST for failure to have proper registration], said Stephen E. Higgins, director of the Bureau of Alcohol, Tobacco and Firearms. The bureau said 425 people had been arrested by 4 p.m. and the total was expected to exceed 600."*

This is the real beginning of the END, dear ones--it is now, in many states (and this is where the show begins), illegal to have any unregistered handguns and many classifications of rifles. Moreover, the forces will begin with known criminals so they

can show you-the-people that they are of "good intent"--NO, IT IS TO SUCKER YOU IN AND YOU WILL HAND OVER ALL METHODS OF SELF-DEFENSE--VERY, VERY SOON!

Now try this one and see how many of you become ill: **POLICE SEIZE FIRM, 'SELL' IT BACK.** Rocky Mountain News, Sun., Aug. 25, 1991: Edgewater (Colorado): **Edgewater pawnshop owner accused of not filling out paperwork, ordered to pay \$50,000.**

Edgewater police closed the business of a man accused of violating a law by not filling out paperwork properly, then demanded he pay them \$50,000 to get his business back.

The seizure of Sheridan Trading Post and Pawn Shop, 2495 Sheridan Blvd., has raised questions about Colorado's "asset forfeiture" laws and has sparked accusations that police harassed a business that didn't fit the plans of Edgewater's city government.

On May 17, a team of armed "examiners" led by Edgewater Detective Mike Marchese entered the business, which police suspected of being a fencing operation.

Police were armed with an "asset forfeiture order" signed by Jefferson County District Judge Tom Woodford. It declared the shop an "ongoing criminal activity" and a "class-one public nuisance."

The officers boarded up windows, seized cash, checkbooks and merchandise, padlocked the doors and kicked out owner Dean R. Porter, 59.

But when police examined the business, they found no evidence of fencing. In fact, Marchese said his squad wasn't even looking for stolen property because Porter wasn't accused of dealing in stolen goods.

*Instead, he was accused of **improperly filing the reports pawn-brokers must make to police** on loans and purchases.*

"It was for criminal violations of the reporting procedure," said officer Marchese.

But Tom Leadabran, the deputy district attorney in Jefferson County who handled the asset forfeiture case, insisted that the case against Porter was a serious one.

"It wasn't a single isolated incident," he said, "He had committed a string of felonies. Failure to report, theft by receiving....I don't know how many." [Look carefully--this is for this NEW gun confiscation, friends--no matter what they do or how they do it--further, the D.A. said: "I don't know how many..." So, what happened to citizen's rights? What happened to "innocent until proven ----"? YOU are likely NEXT!]

Those laws, said Leadabrand, are to prevent thieves from using pawnshops to unload stolen goods.

No criminal charges have been filed, however. Jefferson County deputy district attorney Joseph Gilmore said he was "still reviewing files."

But Porter said the incident "has already cost me what I spent most of my life working for."

*The confiscated goods--both from his pawnshop business and his separate **gun business** under the same roof called Dean's Firearms--were worth almost \$500,000, the largest seizure in Edgewater history.*

Under Colorado's "asset forfeiture laws", authorities may seize the assets of suspected criminal enterprises without proving crimes or even making formal charges. Suspects must go to court to win back their possessions by proving they were not ill-gotten gains. Law enforcement agencies get to keep what they seize.

After the raid, Edgewater and Jefferson County authorities offered to settle the case by giving Porter back his business in exchange for \$50,000.

Originally, police didn't want cash. Instead, they presented Porter with a lengthy list of items they wanted from his pawnshop, including guns, ammunition, tools and photo and office equipment.

He refused and considered fighting the seizure in court. But on June 7, with his bills mounting and on the advice of attorneys, Porter compromised.

"I agreed to pay them \$50,000 for the keys, promised not to sue them, agreed to move out of Edgewater and not open another pawn-shop in Jefferson County for five years," he said.

In court documents, the authorities describe the agreement as 'judicial economy'.

"It was extortion," Porter said.

The seizure is the first police confiscation of a pawnshop under the asset forfeiture provisions of Colorado's "public nuisance" law, said Howard Mendelsohn, executive director of the Colorado Pawn Brokers Association.

That law is normally used to close drug houses, prostitution houses or similar nuisances and confiscate them as the fruits of illegal activities.

The seizure also may be the first time Colorado police have confiscated a building and property because employees failed to fill out paperwork correctly.

"I have never heard of such a thing as this," said Mendelsohn, who helped write state reporting statutes for pawnbrokers.

"It sounds like a fairy tale. How do they justify, taking a man's business over something like this?"

This story goes on for another couple of columns but I think you get the picture. Accidental that it came on the very day that Bush had this "gun sweep by breaking and entering without warrant"? You see, a state doesn't even need restrictive gun registration laws to invade and seize. Remember that, in the case above, the \$50,000 was IN ADDITION TO THE OVER \$500,000 IN CONFISCATED GOODS.

Well, where are all those attorneys and judges who stand up for the law? This man could not find an attorney who would take his case and he had funds left to fight the case. If you, America, don't need a Constitutional Law Center then I cannot imagine who does!

LEGAL SHENANIGANS

Update on the Dharma/Oberli property case, after already into the case by hundreds of thousands of dollars--a lot of it your own taxpayer (RTC) money to the little slime sucker who represents the opposition. Yesterday morning was "another" hearing to "insist that he (S.H.) accompany a photographer" through D&O's dwelling--"to make sure they haven't "trashed it". He already did the photo bit on the outside. Now, thousands of dollars later--he pushes for "inside visitation" and the session went as follows. D&O's attorneys came specifically for this nuisance hearing--from San Francisco and Sacramento--Horn from Beverly Hills/Santa Monica (at RTC (your) expense, of course). "Our" attorneys met D&O adequately ahead of court time (8:30 a.m.) and walked to the court house. They then went to the appointed courtroom but went upstairs to find it was in error. So, some less than five minutes "late" they were rushing down the corridor just outside the court room--only to find Mr. Horn RUSHING MADLY down the hall in opposite direction. The assumption was he had forgotten something and was hurrying to retrieve it prior to the case being called. Dharma said to "Claude"-- nope, the slime pushed the case and it's over. "No, he couldn't do that," was the reply. Scott halted Horn long enough to actually serve papers in a packet to Mr. Horn--who accepted it without comment and rushed on. Once in the courtroom all took their seat prepared to await Mr. Horn's return. Dharma said, "He won't be back, he is half way to L.A. by now!"--so more waiting. Then Scott inquired of the Bailiff if the case had perchance been called and he indicated yes.

Nothing was happening in the courtroom--nothing being heard, etc. Scott asked permission of the judge to inquire regarding the case. The Judge said Horn was rushed and since no one was here for O&D that he had had to rule by default in favor of Mr. Horn--**with sanctions**. He said, "If you can return Horn to this courtroom--I will hear the case." Of course **no HORN**. Back to the courtroom where the encounter in the hall was relayed to the Judge who said that that was improper--that Mr. Horn, as an "officer of the court", was obligated to acknowledge presence and return to the

courtroom. So another search was made for Horn--missing of course, like the 13th amendment while, I'm sure, Mr. Horn recited his Kol Nidre vows to lie, cheat and steal.

Back to the courtroom and this time to ask the Bailiff if he had been asked to step outside to check on lawyers or clients. Bailiff said "no" because "the Judge asked Horn if he had seen you outside! Mr. Horn said no."

Now, I am going to tell you the punch-line that these ones don't yet know--**Steven Horn saw the group enter the building and go up the escalator toward the wrong courtroom and rushed like mad to the proper place where he could be "first" heard!**

I repeat, America, you are in desperate circumstances--there is nothing--NOTHING--the adversary will not do to stop you-the-people. God help you all to see and hear. Well, what do you do? You keep on keeping on for just as long as you can breathe. We can get the Law Center going and get some lawyers of honor working for you--but they cannot do it without living also even though they are willing to do it at rock-bottom costs. You will have to help, dear ones--and appreciation is great unto you who have done so.

The remainder of yesterday was spent with ones on the subject of the Constitution and to make the next move in the legal aspects; this time on taxation unConstitutionality--but it is a mammoth chore at best. All groups MUST harness power of unity for as you can see herein--it has begun. The "disarm Americans" is under way--it has nothing to do with "crime"--it is an all out attempt to disarm America and abolish your Constitution!

Now, precious ones, you are going to face facts and TRUTHS or you are not going to salvage freedom. I know not how to cause you to see and hear that it is YOU who is at stake. The Anti-Christ/God of the aeons of prophecy is upon you and enslavement and terror are at your very door--your own door. This is a play for Total Control of Your World!

REVELATION

I am going to quote you something from the Book of Revelation and in reading it keep in mind all of our lessons, including the term "Jew" as being only a reference **since the late 1700's. You ones had best begin to face facts that the evil adversary has stolen the Judean heritage and taken the birthright of the very Hebrew people. Today you are faced with total evil of ungodly beings.**

Revelation 2:9. I know how much you suffer for the Lord, and I know all about your poverty (but you have heavenly riches!). I know the slander of those opposing you, who say that they are Jews--the children of God--but they are not, for they support the cause of Satan.

Rev. 3:9. Note this: *I will force those supporting the causes of Satan while claiming to be mine (but they aren't--they are lying) to fall at your feet and acknowledge that YOU ARE THE ONES I LOVE.*

There is no way that I can stress the urgings to read and re-read that which is called "REVELATION" for each time you do with petition for my clarification--shall you see the truth.

Most was not tampered with in the book of Revelation for none of the scholars who changed the books of what you call "the Bible" knew and understood John's prophecies well enough to change it. What they understood, they did change--but you will not find these passages spouted from the local pulpit in truth.

By the way, you beloved ones who are deeply concerned about Rev. Robert Schuller's recently being stricken--YOU SHOULD BE for the man is no longer the one you believe him to be. He is now a "tool" of the adversary and the blessed one realizes it not. He will become even more "patriotic" and urge capitulation on all demands by the government--he has long been taken as a tool of the dark government New World Order and it will become very transparent here on in.

I am going to take leave now, so that Germain can have opportunity to work for if we can finish his JOURNAL this week, we can move back into more current adventures. However, this series of PLEIADES CONNECTIONS, **with the OPERATORS/OWNER MANUAL ARE THE MOST IMPORTANT BOOKS TO BE PLACED ON YOUR PLANET--EVER! WE HAVE NOT NEARLY BROUGHT ALL, BUT IF YOU DIGEST THESE YOU WILL COME INTO KNOWING!** Blessings be upon you as you walk this critical journey for we can light the path and show the way, we can even carry you part-way if you ask--but we cannot do it FOR you. Salu.

I have but one more painful statement to make for you close ones. Allow the situation with ASSK to go its way. From the letter received, you can see that the once warm and loving House of God has fallen to the adversary.

Another point which also pains you as to one who once spoke for me and for the Brotherhood of Light, now speaks only for the elementals (which is ridiculous for "guides" are not of "lesser" stature and ones of the "fringe commands". If my name appears as speaker among the writings of these various ones--IT IS NOT ME--ATON/HATONN. They have been placed in your pathway to stop your journey into the Truth and Light with God. All have opportunity to come into truth but they choose to drift farther and farther from the fold--so be it for each has free-will choice of pathways.

I have even worse news for you who have come to listen to "channels" who tell you of wondrous "landings" and "evacuations" by space brothers. The projections are so

tainted now as to be as foolish as the "rapture" to fluffy radioactive "clouds". I plead with you to study and read ALL with reason and WITH GOD, for the time of LIES is upon you--you are in chaos and control of evil and it will consume you if you cast it not off.

Dharma, you will, child, continue to be painfully tested and pushed, threatened and pulled. You will stay within my hand and heed my voice for some of the most disappointing assaults are yet to come. Bless those ones who give unto you the testing for it is their job to do so and it is not yours to know why. So be it.

Hatonn to clear, please.

CHAPTER 14

REC #2 GERMAIN

WED., SEPTEMBER 4, 1991 2:12 P.M. YEAR 5, DAY 019

WEDNESDAY, SEPTEMBER 4, 1991

In the wisdom of our elders do I come; I am Germain. Cohan of the Seventh Ray, Master teacher of alchemy and transmutation--in your service that together we might find the higher purpose of man and your own journey that we might be again whole.

To begin, I shall comment on the biggest bunch of incredible lies I have witnessed in blatant stupidity. The children on the ballfield in Winnetka (I believe this is in Illinois, U.S.A.) were struck by "lightning", one being killed and another injured. It was told by witnesses that the sky above the field was totally clear and there was "the loudest explosion I have ever heard and then a red ball hit the 'dead' boy in the chest". The casual explanation was that there can be electricity discharges from a dry sky, etc. Yes there can be--but NOT like that! What is described here is a deliberately aimed and discharged particle beam from a shielded platform some distance into your atmosphere. There will be more and more of these similar incidents reported all around the globe but especially in the U.S. as you are being set up to fear and unify against the "Little Gray Aliens". An almost identical happening occurred on or about the same day in Minnesota at a golf tournament. Dear ones, be attentive for you are under attack. You are being set-up for a very "big" one.

I wish we had time to simply plot activities and connect them for you--those from what appear natural activities to manipulations. For instance, How many of you heard of major UFO sightings in Bucharest, Romania in June? These were major, proven sightings and yet it doesn't even make your media. The big worry should be around earthquakes, however. There are lots of earthquakes, for instance, in Japan--there are several a week of what you would call major. There were major shakers every week in that location of the past three months. You might say, "Well, they are used to it and they are still there!" So be it, but listen to this little addition of information which might startle a few die-hard non-startlers.

*"A two mile active geological fault is **located directly beneath THREE NUCLEAR REACTORS IN NORTHERN JAPAN.** Documents show three nuclear generators, including the new Fugen converter-reactor, are situated directly on the fault line in Fukui Prefecture, while Japan's first fast-breeder reactor, Monju, is located just two miles away."*

So, next you might say, "..but it doesn't matter for any radioactivity will dissipate before it reaches me in Australia, the United States, Canada, etc.". Really? Why do you think Mt. Unzen continues to erupt? To put plenty of particulate matter into the air

to fall down when it becomes radioactive--and that ash has already encircled the globe!

Back to our subject, Dharma--TRANSMUTATION OF MAN.

WORLD DESTINY LIES IN MOTHER LOVE

The destiny of the world today is in the hands of the women of the world. At no time in human history has the healing balm of mother love been so urgently needed nor so saddeningly missing.

Woman is created to hold in the deepest depths of her soul the urge to give and to protect. Her role on Earth is to nourish and give of herself as Mother Earth so bounteously gives from her body to your bodies.

Man's way of life all down through the ages has submerged woman's rightful place **beside** her mate and made her role that of an "appendage" rather than that of an equal half of a perfect whole.

Corruptness has become the way of life of mankind. Your world today is indeed "sick"--there is trouble in every land--in every home. All men--everywhere--need the healing power of mother love. Greed, doubt and fear fill men's hearts. WHY? The **cause** of all these negative traits springs from a deep-rooted sense of **insecurity**. Only LOVE can cure the world's ills--**and Mother love can and will bring BALANCE to your world if women would express their innate desires of love and protections and cease the facade of masculine demands.**

There is a beautiful writing in a book called THE BROKEN WINGS, By Kahlil Gibran who wrote in his native Arabic. He has written so beautifully of "mother" in so many places but I wish to share a most beautiful passage.

"...The most beautiful word on the lips of mankind is the word 'Mother' and the most beautiful call is the call of 'my Mother'. It is a word full of hope and love, a sweet and kind word coming from the depths of the heart. The mother is everything--she is our consolation in sorrow, our hope in misery, and our strength in weakness. She is the source of love, mercy, sympathy, and forgiveness. He who loses his mother loses a pure soul who blesses and guards him constantly.

"Everything in nature bespeaks the mother. The sun is mother of Earth and gives it its nourishment of heat; it never leaves the universe at night until it has put the Earth to sleep to the song of the sea and the hymn of trees and flowers. It produces them, nurses them, and weans them. The trees and flowers become kind of mothers of their great fruits and seeds. And the mother, the prototype of all existence, is the eternal spirit, full of beauty and love.... The word 'mother' is hidden in our hearts and it comes upon our lips in hours of sorrow and

happiness as the perfume comes from the heart of the rose and mingles with clear and cloudy air."

AGAIN--HUNG UP ON REINCARNATION

Yes, I am about to finish this book because I have given you the material you need with which to KNOW ALL. YOU must now do your portion. However, we will take a few inquiries and see if we can bring some kind of peace into the equation.

The big question is always: "If I have lived before, why do I not remember who I am or who I was in another lifetime?"

I MUST always start by reminding you that your body is NOT you. You are a Mind-Idea--a Cosmic Identity. You have always lived. Your body is but the motion of actions expressed by either your senses or your Mind, or both. Your brain records memories upon your senses in order that the motion you need to express in the building of your body can be controlled. When your body wears out, your brain-memories wear out with it but they record those memories in the inert gases which constitute the seed. The seed repeats the essentials but does not repeat the non-essentials sufficiently well for you to remember if you ate chicken on a certain day thirty years ago unless it was connected to an event of sufficient importance to stamp it as such--for instance, almost dying by a chicken bone in the throat.

Things of importance are NEVER forgotten, however, When you see a baby trying to hold onto its father's hands as the father lifts it, that is an atavistic memory of the period when humans had to live more or less in the open. Memories and instincts are indelibly carved upon the memory in the seed and are reproduced in reincarnation after reincarnation for millions of years. It is important that one remembers things upon which his life and growth depend, but it is of no importance whatsoever that he remember that he was once John Jones of Boston or that the wind blew from the northwest on his wedding day of three thousand years ago. Nature has her way of recording these memories in the seed for future experiences. One of them is to record it in the body cells themselves as though each one had a little brain of its very own. This is what is known as cell-memory. It means that each little particle of a body knows its purpose in a body. Your body could not live and grow without that provision of Nature. This you should understand. If, for example, you want to walk, you have to order your body to act for you. Every little part of your body is continually acting and doing its work. You do not tell it to do it. If you cut your finger, you do not order the cells of your body to heal it. They do it themselves. They are Mind-centered as you are. Cell-memory of their purpose is recorded in them and they obey orders just as your whole body obeys you.

There are a hundred functions of your body that you do not know about. There are mechanical functions that you give no thought to. They work automatically without receiving orders from you. They receive orders from themselves, however, and those orders from cell-control are memories of thousands of reincarnations which have

passed one generation of memories to another, so that the insignificant gland of millions of years ago, which began to form for the purpose of creating adrenalin in your body, is now a complex chemical plant which operates without any direct orders from you. In fact, you never gave it orders since its beginning. You DESIRED it as a body-need and your desire created it. Then your body remembered it and has repeated it millions of times. Those essentials of life are what you remember from incarnation to incarnation, not that YOU lived in Ohio under some name or another at some other time. These memories can be brought back into consciousness but WHY? You are to learn from the experience of THIS encounter with physical experience itself.

Now, consider the cell-memory of a spider who gradually learned how to build a web in order to catch food. Each new generation of spiders is not taught how to make a web. It is a necessity of their existence so it is interwoven into the cell-memories of millions of incarnations. Each new reincarnation adds to its proficiency and that new efficiency is added to the seed and imparted into the next body as cell-memory. Each time an adjustment comes to the environment the needs of the being are implanted into the seed and this is often the end result called "natural selection".

This, actually, should prove reincarnation, for it is inconceivable that a full-grown SPECIES of any form of life could be spontaneously created in one short generation. The evidence of millions upon millions of repetitions is very plainly present in every living thing which grows.

But, of course, the next point is that a person lives some 70 to 80 years and is put into the ground after what is called death and that is confusing.

The only hurdle which you must surmount is the "time" element. You have not yet learned that cycles are alike, but of differing durations. By that I mean that a life cycle of seventy years for a man to express physical life and death is no different from a sound cycle of four-thousandths of a second. Each sound cycle, which lives only four-thousandths of a second, lives and dies just as you do in your own cycle. You hear the "reincarnations" of sound bodies come and go so swiftly that millions of those reincarnations seem like one continuous sound. There are rest periods between realizations which balance the action periods. The interval is always in balance with the action.

All "thinking" energies birthed into the physical form are shrouded by the "forgetting". What then comes to happen is that after many generations the very source is forgotten. It is not just a time of "remembering" who YOU are--but that WHICH YOU ARE and that which is your civilization and relationship with God.

I wish to remind you that you will find as you restudy the material that it is utterly SIMPLE and can be fully comprehensible to you.

Do not say, not even for a moment, that it is "over your head" or that you cannot understand it. You must think it over and over again, then meditate upon it until what

you now read with your senses, you will gradually KNOW. **IT WILL BECOME A PART OF YOU.**

The more you turn into thinking cosmically instead of sense physically, the more you find yourself using God's Mind AS your own Mind--and God's hands as YOUR hands. That is exactly the way that it MUST be.

I must go over a few points to emphasize a second time the important points to hold in Mind.

If you can add up to nine, or realize that you breathe inwardly and outwardly from a balanced center within you, you can understand the workings of the most complex phenomena in all Nature. We must accentuate the fact that God never allows more than half of nine for any action of man or Nature. That one half of nine belongs to Creation. That one half is the limit of man's or Nature's "free will" or for man's and Nature's bodies to mature to their maximums.

THE OTHER HALF OF THE NINE BELONGS TO GOD. THAT WHICH HE GIVES MUST BEGIN TO BE REGIVEN IN THE REACTIONS TO ACTIONS.

God creates all elements of matter in His own image--PERFECT--out of which all Nature and man create their bodies and their lives and desires IN THEIR OWN IMAGE. At maturity, which is four-and-a-half of the NINE of Creation, Nature and man must begin to regive their bodies, their desires and their lives back to God for another lesson in life. This process continues with all Nature and man as long as his planet will sustain life or until man has fully become ONE with God. We call that process "evolution" but God intends it as his school of many classes from which all will graduate when they have learned how to manifest the IDEA of themselves AS THAT IDEA EXISTS IN GOD'S MIND.

There is a basic thing which all those who desire to attain supremacy must place first in their behavior to themselves and to their fellow men. That is that every action and reaction are inexorably followed by their effect, or product, and this third attribute to motion is what continues Creation into infinity.

Your civilization has not yet advanced to the stage where it gives equal import to the spiritual QUALITIES, which cannot be counted or measured, and the physical QUANTITIES, which can be counted and measured. Both come from God's body, the universe. The materialist overbalances his taking of QUANTITIES and the masters among men give full attention to the necessity of the QUALITIES as a part of their nature and identity.

Man creates his own personality and identity by the measure in which he balances the QUANTITIES of God's body and the rhythms of it which are its QUALITIES in the making of his own body, his own personality, and his own identity.

The action and reaction of the pendulum create the product called TIME. They balance and thus extend Creation into infinity. Man bargains. One takes more and gives less; thus man's world is threatened with extinction by man. The basic THREE which cannot be added to or subtracted from is referred to as THE DIVINE TRINITY.

The Divine Trinity consists of God, the undivided Father-Mother of Creation, and the two divided father-and-mother pairs which constitute Creation.

GOD THE
0-----0-----0
FATHER - MOTHER

There is nothing else in the universe for this is the principle of the light-wave which man calls ELECTRIC CURRENT. Creation consists only of light-waves. God creates only sex-divided father and mother bodies by dividing His thinking. Father and mother bodies unite their sex conditions to create other father and mother bodies. There is naught else in all the universe.

I would like to leave this message off at this point for I ask that you ponder upon this information. Thank you, Dharma, for your service and blessings flow upon you all who seek--for you shall be given to "find".

I AM --- GERMAIN